



TW
Surgical

ENDOSCOPY



**UK
CA** **CE**



TW Surgical

Treasure Wright (U.K.) Ltd.



www.twrightmedical.com







info@twrightmedical.com

semi-flexible, 30.000 pixel

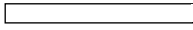
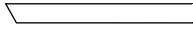
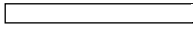
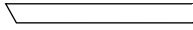



PAEDIATRIC-CYST

Length	Ø	0°		30°	
					
119,5 mm	1,9 mm	TWS 32155		TWS 32157	
187,5 mm	1,9 mm	TWS 32156		TWS 32158	

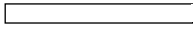
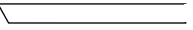
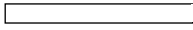
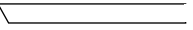

HD PAEDIATRIC-CYST

Length	Ø	0°		30°	
					
187,5 mm	2,7 mm	TWS 32159		TWS 32160	

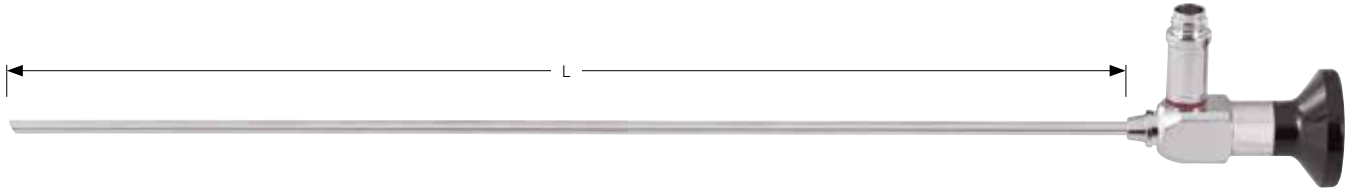

HD CYST

Length	Ø	0°		12°		30°		70°	
		Diagram	Color	Diagram	Color	Diagram	Color	Diagram	Color
302,0 mm	2,7 mm		TWS 32161 ■			TWS 32166 ■		TWS 32169 ■	
302,0 mm	2,9 mm		TWS 32162 ■		TWS 32164 ■	TWS 32167 ■		TWS 32170 ■	
302,0 mm	4,0 mm		TWS 32163 ■		TWS 32165 ■	TWS 32168 ■		TWS 32171 ■	

4K ULTRAHD

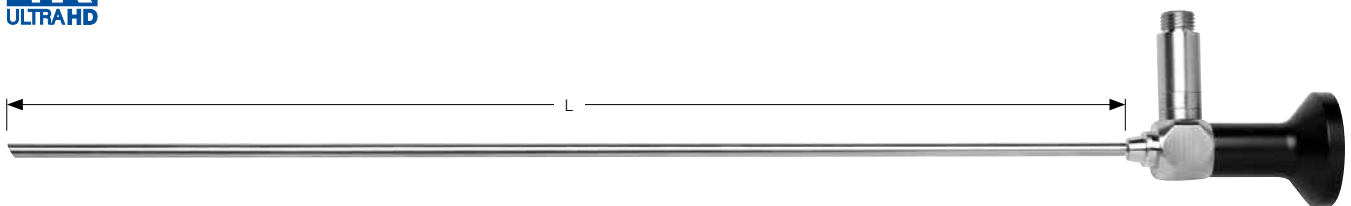

4K CYST

Length	Ø	0°		12°		30°		70°	
		Diagram	Color	Diagram	Color	Diagram	Color	Diagram	Color
300,0 mm	2,9 mm		TWS 32172 UHD		TWS 32174 UHD		TWS 32179 UHD		
300,0 mm	4,0 mm		TWS 32173 UHD		TWS 32178 UHD		TWS 32180 UHD		TWS 32181 UHD

3-Shaft Endoscope

Treasure Wright (U.K.) Ltd.

128-160 City Road, London, EC1V 2NX, United Kingdom
 info@twrightmedical.com

HD Compact Cystoscopes

HD Compact Cystoscopes, atraumatic distal tip, tapered sheath, working channel, 2 x lateral suction-irrigation connections

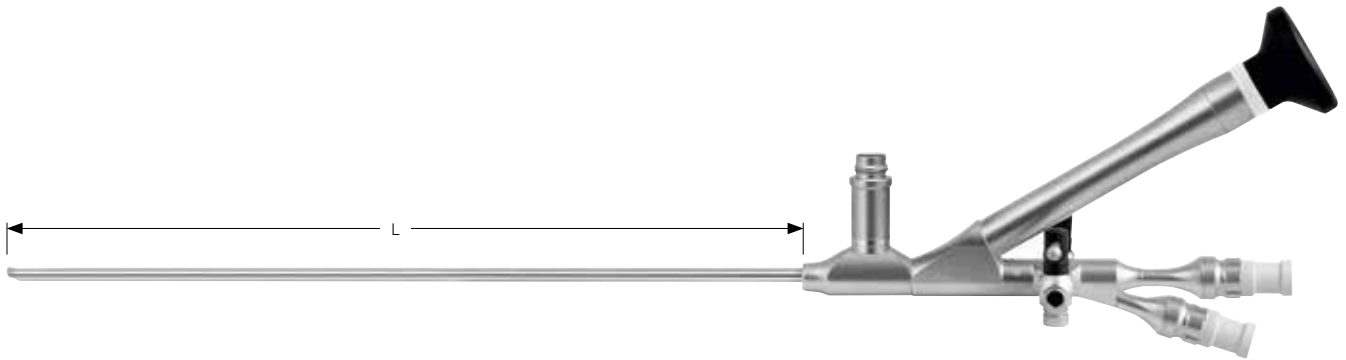

17.000 pixel	Length	Ø	Ø Working channel	for instruments	0°
Mini / Paediatric	150,0 mm	4,5 6,5 8,1 Charr.	4 Charr.	1 x 3 Charr.	<input type="checkbox"/> TWS 32182
Mini / Adolescents	150,0 mm	6 7,5 9 Charr.	5,1 Charr.	1 x 4 Charr. 2 x 2,4 Charr.	<input type="checkbox"/> TWS 32183

40.000 pixel	Length	Ø	Ø Working channel	for instruments	0°
Adults	150,0 mm	7,5 9 12 Charr.	6,8 Charr.	1 x 5 Charr. 2 x 3 Charr.	<input type="checkbox"/> TWS 32184
Adults	220,0 mm	7,5 9 12 Charr.	6,8 Charr.	1 x 5 Charr. 2 x 3 Charr.	<input type="checkbox"/> TWS 32185

Cysto-Urethroscope sheaths for adolescents

Cysto-Urethroscope sheath with 2 stopcocks and integrated 5 Charr. instrument channel

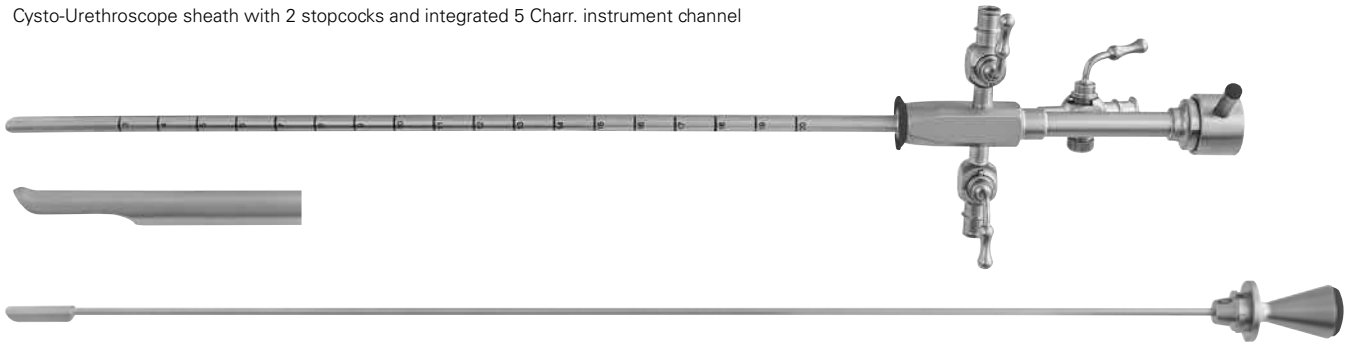

Size	For scopes	Colour code	Complete with obturator	Sheath, only	Obturator, only
15 Charr.	Ø 2,7 2,9 mm	■	TWS 32186	TWS 32187	TWS 32188

Cysto-Urethroscope sheath with 2 stopcocks



QUICK-LOCK

Size	For scopes	Colour code	Complete with obturator	Sheath, only	Obturator, only
16 Charr.	Ø 2,9 mm	■	TWS 32189	TWS 32190	TWS 32191

Capacity for flexible instruments

Size	For scopes	Colour code	For sheath	Telescope bridge	ALBARRAN
16 Charr.	Ø 2,9 mm	■	TWS 32192	1 x 5 Charr. 2 x 3 Charr.	1 x 5 Charr. 2 x 3 Charr.

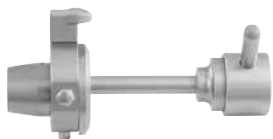

QUICK-LOCK

TWS 32193 16 Charr.

Telescope bridge for diagnostic for Cysto-Urethroscope sheath

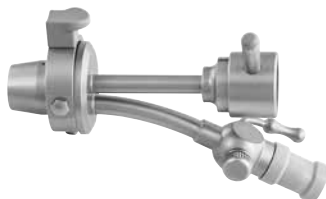

QUICK-LOCK

TWS 32194 16 Charr.

Telescope bridge for Cysto-Urethroscope sheath, 1 instrument channel

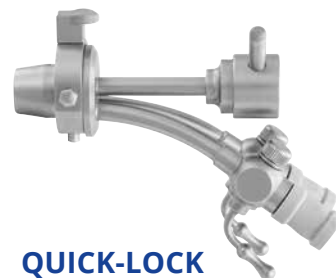

QUICK-LOCK

TWS 32195 16 Charr.

Telescope bridge for Cysto-Urethroscope sheath, 2 instrument channels



ALBARRAN QUICK-LOCK

TWS 32196 16 Charr.

Working insert with deflecting mechanism for Cysto-Urethroscope sheath, incl. safety probe, with ratchet, 1 instrument channel



ALBARRAN QUICK-LOCK

TWS 32197 16 Charr.

Working insert with deflecting mechanism for Cysto-Urethroscope sheath, incl. safety probe, with ratchet, 2 instrument channels

Cysto-Urethroscope sheaths for adults

Cysto-Urethroscope sheaths with 2 stopcocks

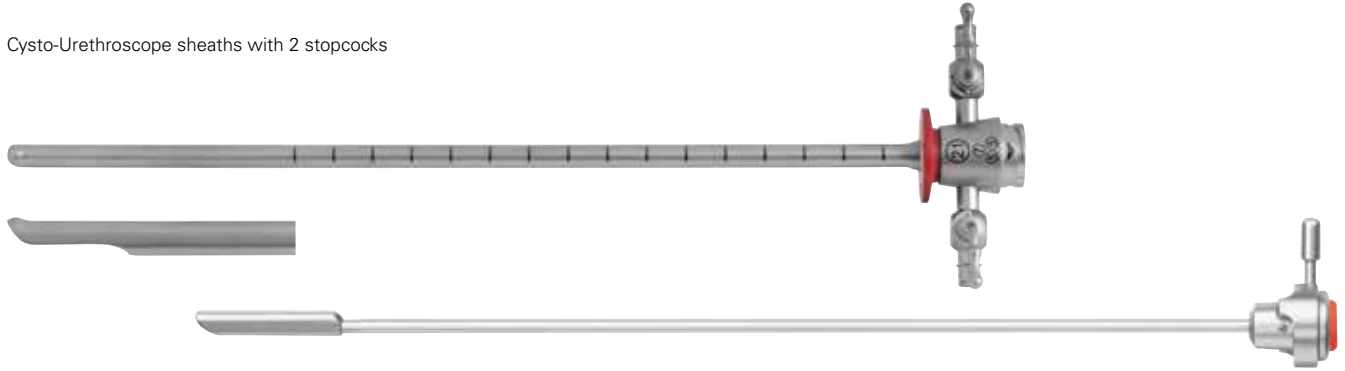

Size	For scopes	Colour code	Complete with obturator	Sheath, only	Obturator, only
17 Charr.	Ø 4,0 mm	■	TWS 32198	TWS 32202	TWS 32208
19 Charr.	Ø 4,0 mm	■	TWS 32199	TWS 32204	TWS 32209
21 Charr.	Ø 4,0 mm	■	TWS 32200	TWS 32205	TWS 32210
23 Charr.	Ø 4,0 mm	■	TWS 32201	TWS 32206	TWS 32211
25 Charr.	Ø 4,0 mm		TWS 32203	TWS 32207	TWS 32212

Visual obturator for Cysto-Urethroscope sheaths



TWS 32213 17 Charr.

TWS 32214 19 Charr.

TWS 32215 21 Charr.

TWS 32216 23 Charr.

TWS 32217 25 Charr.

Capacity for flexible instruments

Size	For scopes	Colour code	For sheath	Telescope bridge	ALBARRAN
17 Charr.	Ø 4,0 mm	■	TWS 32218	1 x 5 Charr. 2 x 4 Charr.	1 x 5 Charr. 2 x 4 Charr.
19 Charr.	Ø 4,0 mm	■	TWS 32219	1 x 6 Charr. 2 x 5 Charr.	1 x 6 Charr. 2 x 5 Charr.
21 Charr.	Ø 4,0 mm	■	TWS 32220	1 x 7 Charr. 2 x 6 Charr.	1 x 7 Charr. 2 x 6 Charr.
23 Charr.	Ø 4,0 mm	■	TWS 32221	1 x 9 Charr. 2 x 6 Charr.	1 x 9 Charr. 2 x 6 Charr.
25 Charr.	Ø 4,0 mm		TWS 32222	1 x 12 Charr. 2 x 8 Charr.	1 x 10 Charr. 2 x 8 Charr.

Treasure Wright (U.K.) Ltd.



TWS 32223 17 - 25 Charr.

Telescope bridge for diagnostic for Cysto-Urethroscope sheaths



TWS 32224 17 - 25 Charr.

Telescope bridge for Cysto-Urethroscope sheaths, 1 instrument channel



TWS 32225 17 - 25 Charr.

Telescope bridge for Cysto-Urethroscope sheaths, 2 instrument channels



ALBARRAN

TWS 32226 17 - 25 Charr.

Working insert with deflecting mechanism for Cysto-Urethroscope sheaths, incl. safety probe, with ratchet, 1 instrument channel



ALBARRAN

TWS 32227 17 - 25 Charr.

Working insert with deflecting mechanism for Cysto-Urethroscope sheaths, incl. safety probe, with ratchet, 2 instrument channels



TWS 32228

Adapter for use in womens Urethroscopy

Optical forceps and scissors



Optical forceps and scissors for use with Cysto-Urethroscope sheaths 19 - 25 Charr.

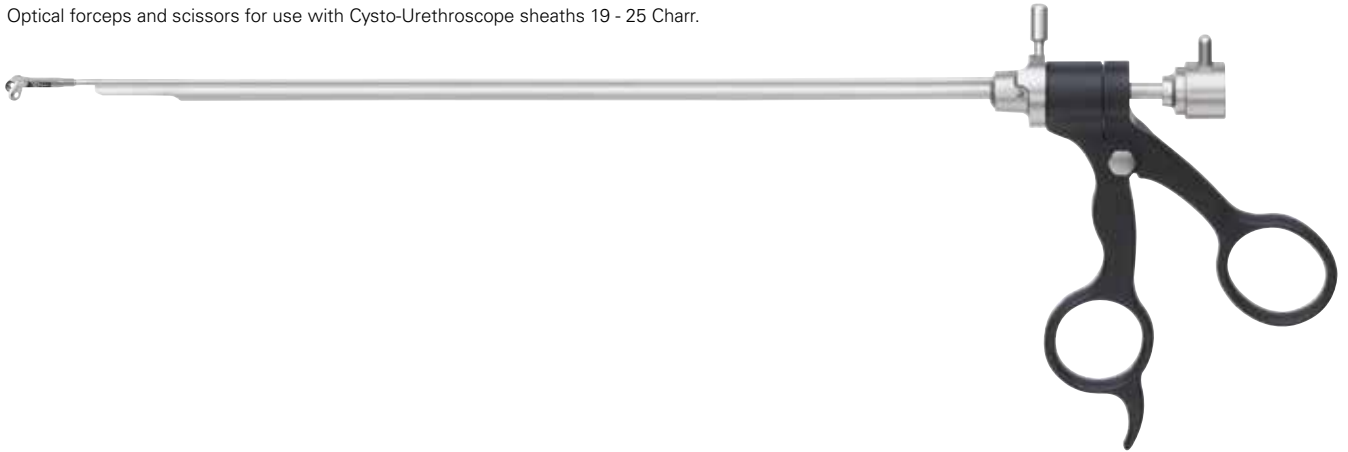

Version	Item number	For scopes
Biopsy forceps, spoon \varnothing 4.3 mm, double action	TWS 32229	0° \varnothing 4,0 mm 12° 30°



Biopsy forceps, short jaw 2.3 mm, double action	TWS 32230	\varnothing 4,0 mm 12° 30°
---	------------------	---------------------------------



Biopsy forceps, short jaw 2.3 mm, double action	TWS 32231	\varnothing 4,0 mm 70°
---	------------------	--------------------------



Biopsy forceps, through cutting, double action	TWS 32233	\varnothing 4,0 mm 0° 12°
--	------------------	--------------------------------



Grasping forceps, double action	TWS 32234	\varnothing 4,0 mm 0° 12°
---------------------------------	------------------	--------------------------------



Hook scissors, double action	TWS 32236	\varnothing 4,0 mm 0° 12°
------------------------------	------------------	--------------------------------



TWS 32237

Adapter for optical instruments for use with Resectoscopy sheaths

Treasure Wright (U.K.) Ltd.

128-160 City Road, London, EC1V 2NX, United Kingdom
info@twrightmedical.com

Optical forceps for use with Cysto-Urethroscope sheath 25 Charr.

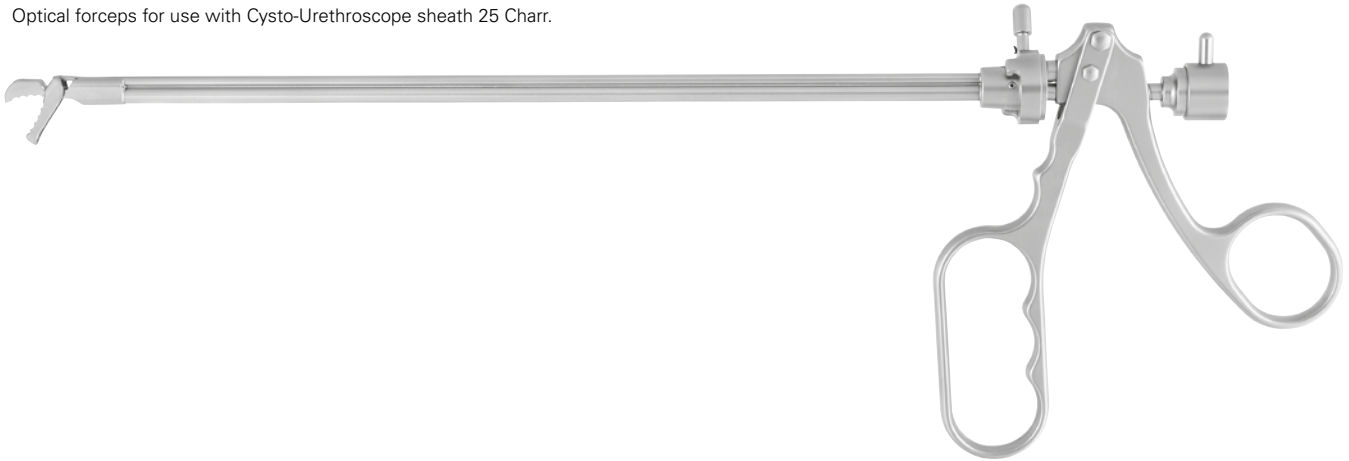

Version	Item number	For scopes
Stone forceps, single action	TWS 32238	Ø 4,0 mm 12° 30°

The optical stone forceps is ideal for processing of small stones and stone fragments.



QUICK-LOCK

TWS 32239

Adapter for stone forceps for use with Resectoscopy outer sheaths with QUICK-LOCK connection



QUICK-LOCK

TWS 32240

Optical working element for punch lithotripsy, QUICK-LOCK connection, for 12° and 30° Endoscopes



QUICK-LOCK

TWS 32241 25,5 Charr.

Lithotripsy sheath with 2 rigid stopcocks, sheath only, QUICK-LOCK connection



QUICK-LOCK

TWS 32243 25,5 Charr.

Lithotripsy sheath with central valve, sheath only, QUICK-LOCK connection



QUICK-LOCK

TWS 32244

Standard obturator for 25.5 Charr. lithotripsy sheath



QUICK-LOCK

TWS 32245

Inner sheath with 7 Charr. instrument channel, QUICK-LOCK connection



QUICK-LOCK

TWS 32246

Adapter for evacuator with tube



Working element mounted on lithotripsy sheath



QUICK-LOCK

TWS 32247

Cystoscopic lithotripter / Stone punch, QUICK-LOCK connection, for 70° Endoscopes

Flexible and Semi-rigid instruments



TW Surgical

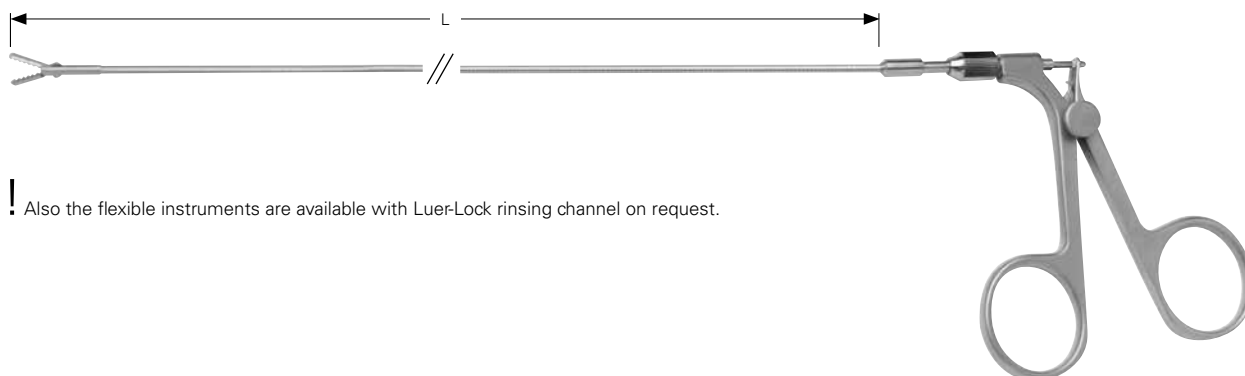

! Also the flexible instruments are available with Luer-Lock rinsing channel on request.

	Version	Ø	Length	Flexible	Semi-rigid
		3 Charr.	400 mm	TWS 32248	TWS 32249
		5 Charr.	400 mm	TWS 32250	TWS 32251
		7 Charr.	400 mm	TWS 32252	TWS 32253
		9 Charr.	400 mm	TWS 32254	TWS 32255
		3 Charr.	400 mm	TWS 32256	TWS 32260
		5 Charr.	400 mm	TWS 32257	TWS 32261
		7 Charr.	400 mm	TWS 32258	TWS 32262
		9 Charr.	400 mm	TWS 32259	TWS 32263
		3 Charr.	400 mm		
		5 Charr.	400 mm	TWS 32264	TWS 32267
		7 Charr.	400 mm	TWS 32265	TWS 32268
		9 Charr.	400 mm	TWS 32266	TWS 32269
		3 Charr.	400 mm	TWS 32270	TWS 32274
		5 Charr.	400 mm	TWS 32271	TWS 32275
		7 Charr.	400 mm	TWS 32273	TWS 32276
		9 Charr.	400 mm	TWS 32272	TWS 32277
		3 Charr.	400 mm		TWS 32278
		5 Charr.	400 mm		TWS 32279
		7 Charr.	400 mm		
		9 Charr.	400 mm		
		3 Charr.	400 mm		
		5 Charr.	400 mm	TWS 32280	TWS 32282
		7 Charr.	400 mm	TWS 32281	TWS 32283
		9 Charr.	400 mm		TWS 32284

Other lengths, diameters and jaw parts available on request.

Treasure Wright (U.K.) Ltd.

128-160 City Road, London, EC1V 2NX, United Kingdom
 info@twrightmedical.com

Semi-rigid instruments with Luer-Lock rinsing channel



TW Surgical

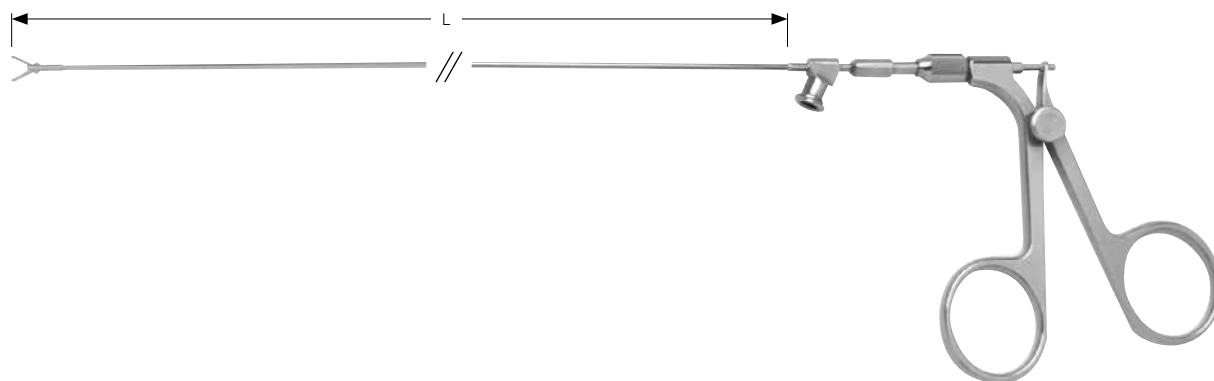

	Version	Ø	Length	Semi-rigid
	Alligator Grasping forceps, double action	3 Charr.	400 mm	TWS 32285 LL
		5 Charr.	400 mm	TWS 32286 LL
	Alligator Grasping forceps, double action	7 Charr.	400 mm	TWS 32287 LL
		9 Charr.	400 mm	TWS 32289 LL
	Biopsy forceps, spoon oval, double action	3 Charr.	400 mm	TWS 32288 LL
		5 Charr.	400 mm	TWS 32290 LL
		7 Charr.	400 mm	TWS 32291 LL
		9 Charr.	400 mm	TWS 32292 LL
	Biopsy forceps, spoon oval, toothed, double action	3 Charr.	400 mm	
		5 Charr.	400 mm	TWS 32293 LL
		7 Charr.	400 mm	TWS 32294 LL
		9 Charr.	400 mm	TWS 32295 LL
	Scissors, blunt, single action	3 Charr.	400 mm	
		5 Charr.	400 mm	TWS 32296 LL
		7 Charr.	400 mm	TWS 32297 LL
		9 Charr.	400 mm	TWS 32298 LL
	Scissors, pointed, single action	3 Charr.	400 mm	
		5 Charr.	400 mm	TWS 32299 LL
		7 Charr.	400 mm	TWS 32230 LL
		9 Charr.	400 mm	
	Hook Scissors, single action	3 Charr.	400 mm	
		5 Charr.	400 mm	TWS 32231 LL
		7 Charr.	400 mm	TWS 32232 LL
		9 Charr.	400 mm	TWS 32233 LL

Other lengths, diameters and jaw parts available on request.

Treasure Wright (U.K.) Ltd.

128-160 City Road, London, EC1V 2NX, United Kingdom
 info@twrightmedical.com



TW Surgical

HyONE Rotat- and detachable semi-rigid instruments

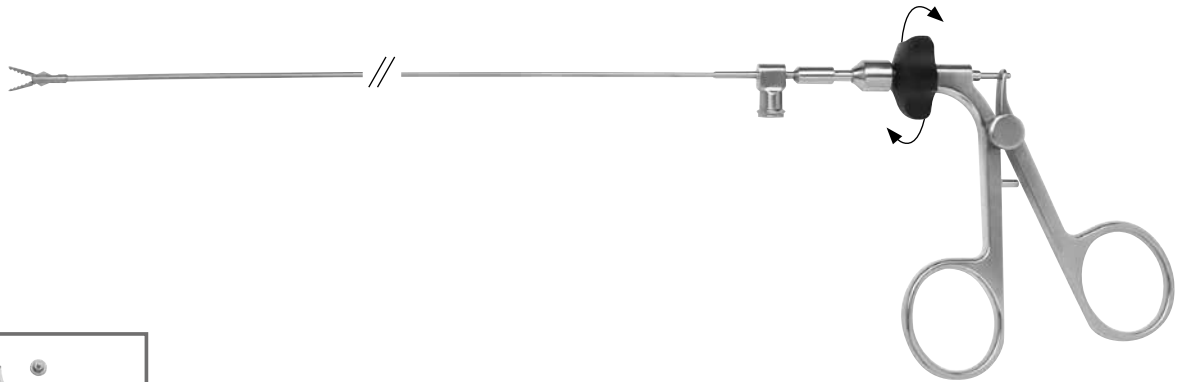

Stainless steel handle can be easily removed and detached for better cleaning.



Integrated overload protection for a significantly longer service life.

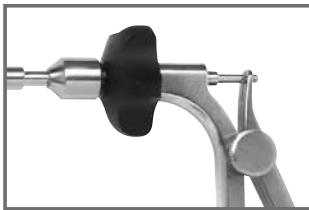

360° rotatable shaft is smoothly to adjust and with a haptic feedback while rotating.

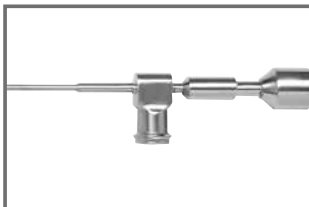

Cleaning port Luer-Lock for an easier and faster cleaning without removing the handle.

TWS 32234 MH

HyONE Handle with rotating wheel and overload protection, stainless steel



Treasure Wright (U.K.) Ltd.

128-160 City Road, London, EC1V 2NX, United Kingdom
info@twrightmedical.com

HyONE Rotat- and detachable semi-rigid instruments WL. 340 mm



TW Surgical

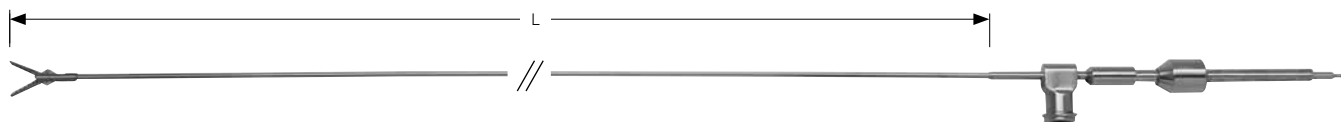







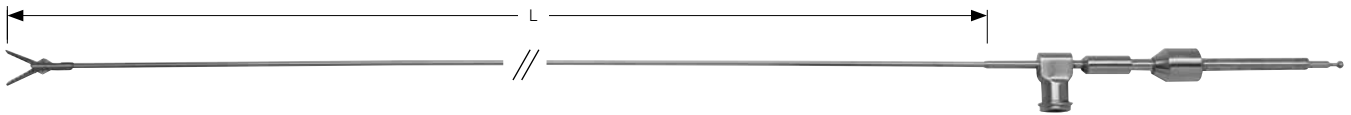

	Version	Ø	Length	Insert, only	Complete with handle
	Alligator Grasping forceps, double action	4 Charr.	340 mm	TWS 32235 MI	74-221-04 MC
		5 Charr.	340 mm	TWS 32236 MI	74-221-05 MC
		7 Charr.	340 mm	TWS 32237 MI	74-221-07 MC
	Biospy forceps, spoon oval, double action	4 Charr.	340 mm	TWS 32238 MI	TWS 32241 MC
		5 Charr.	340 mm	TWS 32239 MI	TWS 32242 MC
		7 Charr.	340 mm	TWS 32240 MI	TWS 32243 MC
	Biospy forceps, spoon oval, toothed, double action	4 Charr.	340 mm		
		5 Charr.	340 mm	TWS 32245 MI	TWS 32246 MC
		7 Charr.	340 mm	TWS 32244 MI	TWS 32247 MC
	Scissors, blunt, single action	4 Charr.	340 mm	TWS 32248 MI	TWS 32251 MC
		5 Charr.	340 mm	TWS 32249 MI	TWS 32252 MC
		7 Charr.	340 mm	TWS 32250 MI	TWS 32253 MC
	Scissors, pointed, single action	4 Charr.	340 mm	TWS 32254 MI	TWS 32257 MC
		5 Charr.	340 mm	TWS 32255 MI	TWS 32258 MC
		7 Charr.	340 mm	TWS 32256 MI	TWS 32259 MC
	Hook Scissors, single action	4 Charr.	340 mm		
		5 Charr.	340 mm	TWS 32260 MI	TWS 32262 MC
		7 Charr.	340 mm	TWS 32261 MI	TWS 32263 MC
	Biospy punch, through-cutting, single action	4 Charr.	340 mm		
		5 Charr.	340 mm	TWS 32265 MI	TWS 32266 MC
		7 Charr.	340 mm	TWS 32264 MI	TWS 32267 MC

Other lengths, diameters and jaw parts available on request.

Treasure Wright (U.K.) Ltd.

128-160 City Road, London, EC1V 2NX, United Kingdom
 info@twrightmedical.com





	Version	Ø	Length	Insert, only	Complete with handle
		4 Charr.	400 mm	TWS 32268 MI	TWS 32271 MC
	Alligator Grasping forceps, double action	5 Charr.	400 mm	TWS 32269 MI	TWS 32272 MC
		7 Charr.	400 mm	TWS 32270 MI	TWS 32273 MC
	Bipolar Grasping forceps, double action	5 Charr.	400 mm	TWS 32274 MI	TWS 32275 MC
		4 Charr.	400 mm	TWS 32276 MI	TWS 32279 MC
	Biopsy forceps, spoon oval, double action	5 Charr.	400 mm	TWS 32277 MI	TWS 32280 MC
		7 Charr.	400 mm	TWS 32278 MI	TWS 32281 MC
		4 Charr.	400 mm	TWS 32282 MI	TWS 32284 MC
	Biopsy forceps, spoon oval, toothed, double action	5 Charr.	400 mm	TWS 32283 MI	TWS 32285 MC
		7 Charr.	400 mm	TWS 32283 MI	TWS 32285 MC
		4 Charr.	400 mm	TWS 32286 MI	TWS 32289 MC
	Scissors, blunt, single action	5 Charr.	400 mm	TWS 32287 MI	TWS 32290 MC
		7 Charr.	400 mm	TWS 32288 MI	TWS 32291 MC
		4 Charr.	400 mm	TWS 32292 MI	TWS 32295 MC
	Scissors, pointed, single action	5 Charr.	400 mm	TWS 32293 MI	TWS 32296 MC
		7 Charr.	400 mm	TWS 32294 MI	TWS 32297 MC
		4 Charr.	400 mm		
	Hook Scissors, single action	5 Charr.	400 mm	TWS 32298 MI	TWS 32300 MC
		7 Charr.	400 mm	TWS 32299 MI	TWS 32301 MC
		4 Charr.	400 mm		
	Biopsy punch, through-cutting, single action	5 Charr.	400 mm	TWS 32302 MI	TWS 32305 MC
		7 Charr.	400 mm	TWS 32303 MI	TWS 32304 MC

Other lengths, diameters and jaw parts available on request.

Flexible monopolar and bipolar electrodes



! Packing unit = 5 pieces

Version	Ø	Length	
		450 mm	650 mm
 Button tip electrode	3 Charr.	TWS 32306	TWS 32316
	4 Charr.	TWS 32307	TWS 32317
	5 Charr.	TWS 32308	TWS 32318
	6 Charr.	TWS 32309	
	7 Charr.	TWS 32310	TWS 32319
	8 Charr.	TWS 32311	
 Needle electrode	3 Charr.	TWS 32313	TWS 32321
	5 Charr.	TWS 32315	TWS 32322
	7 Charr.	TWS 32314	TWS 32323
 Loop electrode	5 Charr.	TWS 32326	TWS 32324
	7 Charr.	TWS 32327	TWS 32325
	9 Charr.	TWS 32329	
	10 Charr.	TWS 32328	TWS 32329

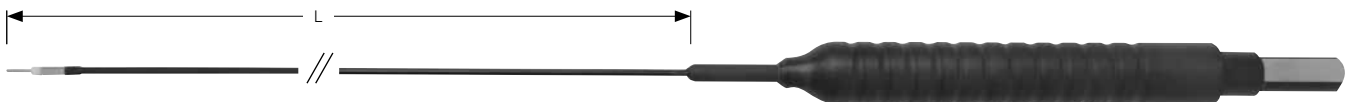

! Packing unit = 1 pieces



TWS 32330 5 Charr.

TWS 32331 5 Charr.

TWS 32332 5 Charr.

TWS 32333 5 Charr.

Button tip electrode, WL. 360 mm

Needle electrode, angled, WL. 360 mm

Needle electrode, straight, WL. 360 mm

Needle electrode, 90° angled, WL. 360 mm

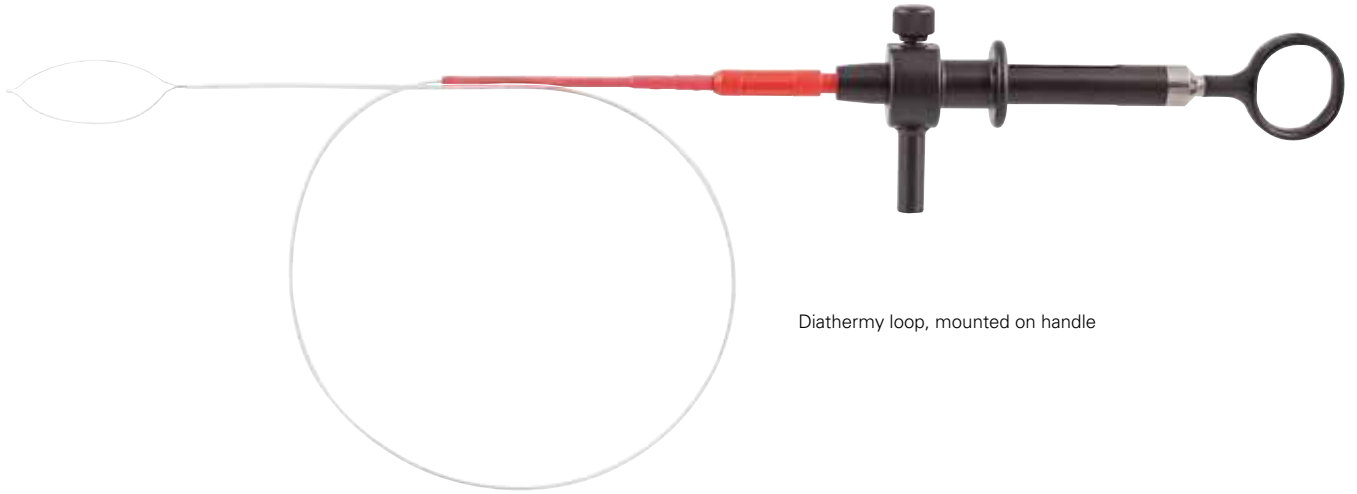

Diathermy loop, mounted on handle

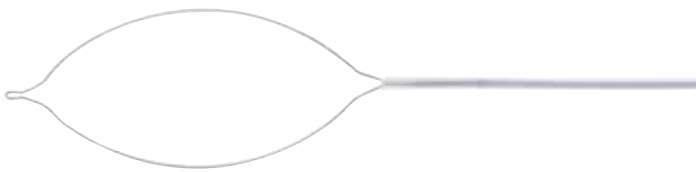

TWS 32334 5 Charr.
TWS 32335 7 Charr.

Diathermy loops with Teflon tube, WL. 600 mm



TWS 32336 5 / 7 Charr.

Handle with HF-Connection

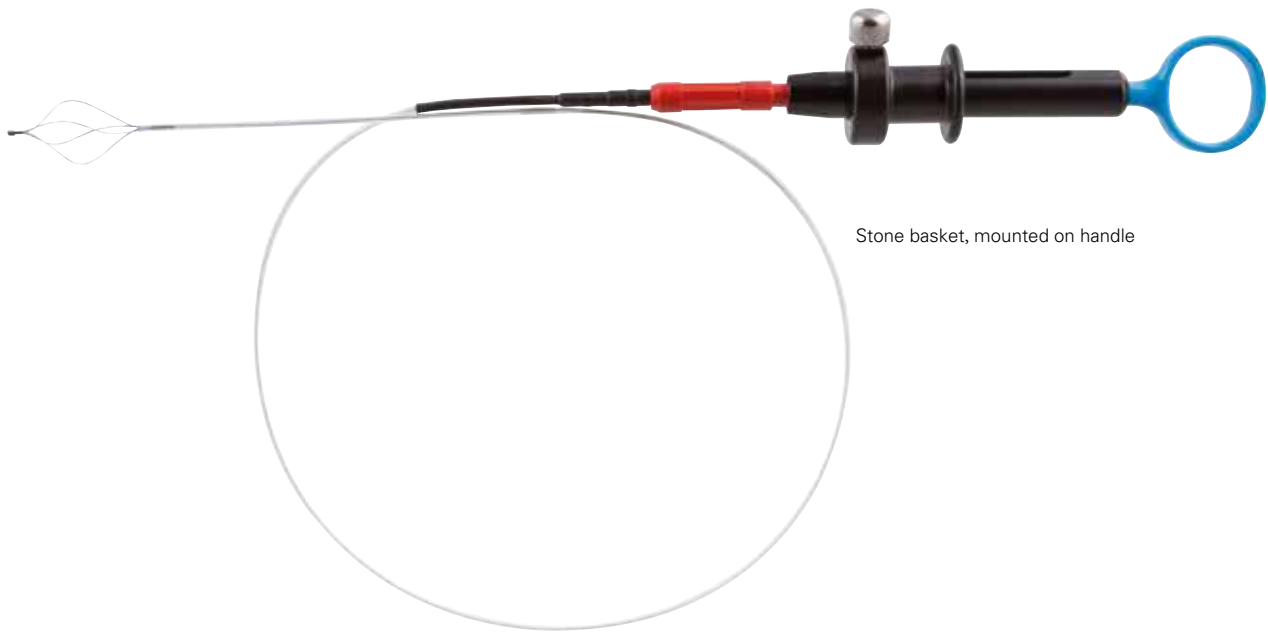

Stone basket, mounted on handle



TWS 32337 3 / 5 Charr.

Handle for stone basket, single-use

Stone dislodger with basket, single-use

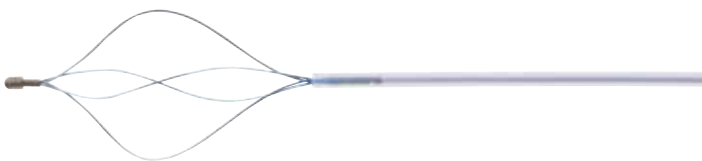

Size	Working length	Wires	4	Wires	5	Wires	6
3 Charr.	900 mm	TWS 32338					
3 Charr.	1200 mm	TWS 32339					
5 Charr.	600 mm	TWS 32340		TWS 32341		TWS 32342	

Monopolar and bipolar connecting cables

Monopolar connecting cables with round plug



Plug instrument side

	Length	Item number
Ø 4 mm	3,0 m	TWS 32343
	5,0 m	TWS 32344
Ø 5 mm	3,0 m	TWS 32345
	5,0 m	TWS 32346
Ø 8 mm	3,0 m	TWS 32347
	5,0 m	TWS 32348

Bipolar connecting cables with flat plug

Plug instrument side



Flat plug, square

Flat plug, round

	Length	Item number	
	3,0 m	TWS 32349	TWS 32357
	5,0 m	TWS 32350	TWS 32358
28,2 mm	3,0 m	TWS 32351	TWS 32359
	5,0 m	TWS 32352	TWS 32360
Ø 7,8 mm	3,0 m	TWS 32353	TWS 32361
	5,0 m	TWS 32354	TWS 32362
Ø 12,3 mm	3,0 m	TWS 32355	TWS 32364
	5,0 m	TWS 32356	TWS 32363

Treasure Wright (U.K.) Ltd.

128-160 City Road, London, EC1V 2NX, United Kingdom
 info@twrightmedical.com

! Working elements could be supplied with open handle as well as downside positioned HF-connection



TWS 32365 19 Charr. für Endoskope / for Endoscopes Ø 2,7 / 2,9 mm, Mini
TWS 32366 24 Charr. für Endoskope / for Endoscopes Ø 4,0 mm

Monopolar working element, passive cutting, single stem, closed handle

! Packing unit = 5 pieces



- TWS 32369** 19 Charr.
- TWS 32370** 24 Charr.
- TWS 32371** 27 Charr.

Loop electrode, 30° angled



- TWS 32372** 19 Charr.
- TWS 32373** 24 Charr.
- TWS 32374** 27 Charr.

Loop electrode, straight



- TWS 32375** 24 Charr.
- TWS 32376** 27 Charr.

Loop electrode, 90° angled, for 0° endoscopes



- TWS 32377** 19 Charr.
- TWS 32378** 24 Charr.
- TWS 32379** 27 Charr.

Knife electrode, 90° angled



- TWS 32380** 24 Charr.

Cone electrode



- TWS 32381** 19 Charr.
- TWS 32382** 24 Charr.

Ball electrode, Ø 3.0 mm



- TWS 32383** 24 Charr.

Ball electrode, Ø 5.0 mm



- TWS 32384** 19 Charr.
- TWS 32385** 24 Charr.
- TWS 32386** 27 Charr.

Roller electrode, smooth, Ø 3.0 mm



- TWS 32387** 24 Charr.
- TWS 32388** 27 Charr.

Roller electrode, smooth, Ø 5.0 mm



- TWS 32389** 24 Charr.
- TWS 32390** 27 Charr.

Vaporisation electrode, serrated, Ø 3.0 mm



- TWS 32391** 24 Charr.
- TWS 32392** 27 Charr.

Vaporisation electrode, serrated, Ø 5.0 mm



- TWS 32393** 24 Charr.

Cut-vaporisation electrode



TWS 32394

Sterilisation tube for resectoscopy electrodes

Resectoscopy sheaths

Resectoscopy continuous flow sheaths with 2 stopcocks, **fixed inner sheath**, surround perforation



Size	Colour code	Complete with obturator	Inner sheath, only	Outer sheath, only	Obturator, only
22 Charr.	<input type="checkbox"/>	TWS 32395	TWS 32406 19 Char	TWS 32399	TWS 32401
26 Charr.	<input type="checkbox"/>	TWS 32396	TWS 32404 24 Char	TWS 32398	TWS 32402
28,5 Charr.	<input type="checkbox"/>	TWS 32397	TWS 32405 27 Char	TWS 32400	TWS 32403

Resectoscopy continuous flow sheaths with 2 stopcocks, **rotatable inner sheath**, surround perforation



Size	Colour code	Complete with obturator	Inner sheath, only	Outer sheath, only	Obturator, only
22 Charr.	<input type="checkbox"/>	TWS 32407	TWS 32416 19 Char	TWS 32410	TWS 32413
26 Charr.	<input type="checkbox"/>	TWS 32408	TWS 32418 24 Char	TWS 32411	TWS 32414
28,5 Charr.	<input type="checkbox"/>	TWS 32409	TWS 32417 27 Char	TWS 32412	TWS 32415

Treasure Wright (U.K.) Ltd.



- TWS 32419** 19 Charr.
- TWS 32420** 24 Charr.
- TWS 32421** 27 Charr.

Standard obturator for resectoscopy sheaths



- TWS 32422** 19 Charr.
- TWS 32423** 24 Charr.
- TWS 32424** 27 Charr.

Visual obturator for resectoscopy sheaths



- TWS 32425** 24 Charr. Kanal I Channel = 5 Charr.
- TWS 32426** 27 Charr. Kanal I Channel = 7 Charr.

Visual obturator with instrument channel for resectoscopy sheaths





- TWS 32427** 24 Charr.
- TWS 32428** 27 Charr.

Deflecting obturator for resectoscopy sheaths

Monopolar connecting cables with round plug



Plug instrument side

	Length	Item number
 Ø 4 mm	3,0 m	TWS 32429
	5,0 m	TWS 32430
 Ø 5 mm	3,0 m	TWS 32421
	5,0 m	TWS 32432
 Ø 8 mm	3,0 m	TWS 32423
	5,0 m	TWS 32434



TW Surgical

Mini HYBRID working element

The new Mini-Resectoscopy system allows either the monopolar or bipolar use. The surgeon just needs to change the HF- connecting cable as well as irrigation liquid and connect the neutral electrode (in case of monopolar use).

No further instrument change is required (time and cost saving). The small diameter of 18.5 Charr. needs only a minor dilation of urethra which is less traumatic for the patient.

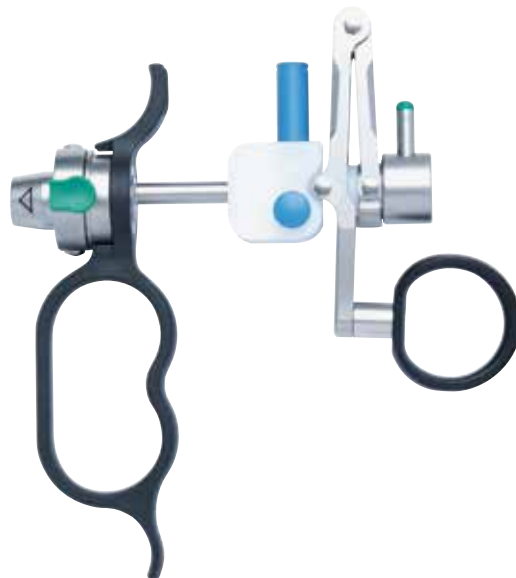
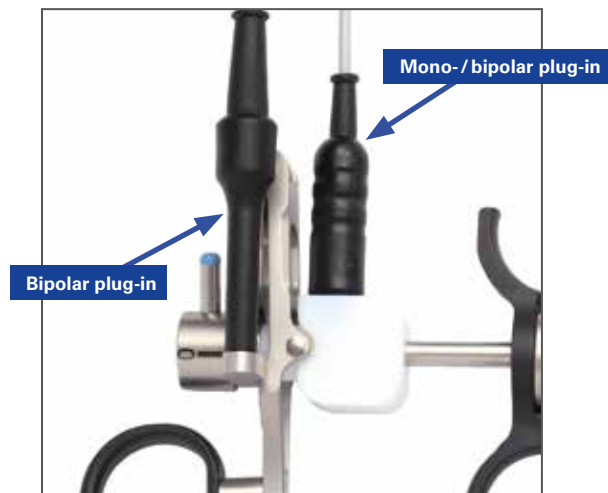

QUICK-LOCK

TWS 32435 17,5 Charr. ■

HYBRID working element, passive cutting, single stem, closed handle

Treasure Wright (U.K.) Ltd.

128-160 City Road, London, EC1V 2NX, United Kingdom
info@twrightmedical.com



QUICK-LOCK

TWS 32436 17,5 Charr. ■

HYBRID working element, active cutting, single stem, closed handle

HYBRID electrodes ! Packing unit = 5 pieces

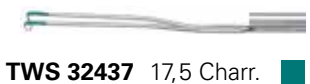

Loop electrode, 30° angled

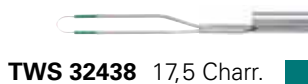

Loop electrode, straight



Knife electrode, 90° angled



Ball electrode, Ø 2.0 mm



Roller electrode, smooth, Ø 2.0 mm



TWS 32442

Sterilisation tube for resectoscopy electrodes

Mini HYBRID Resectoscopy sheath, Obturators

Resectoscopy continuous flow sheath with 2 stopcocks, **rotatable inner sheath**, surround perforation

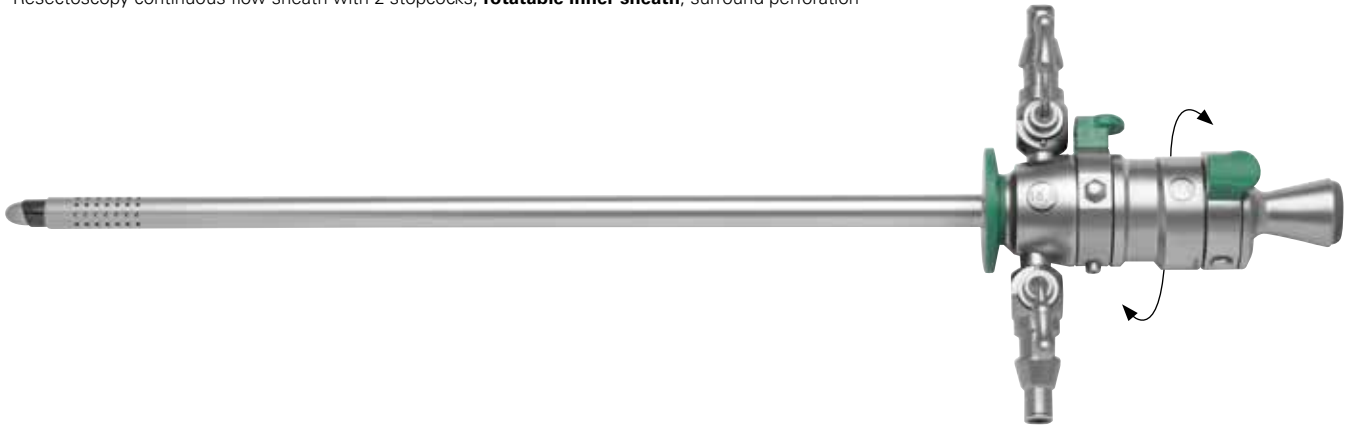

QUICK-LOCK

Size	Colour code	Complete with obturator	Inner sheath, only	Outer sheath, only	Obturator, only
18,5 Charr.	■	TWS 32443	TWS 32444 17,5 Charr.	TWS 32445	TWS 32446



QUICK-LOCK

TWS 32447 17,5 Charr. ■

Standard obturator for Mini HYBRID resectoscopy sheaths



QUICK-LOCK

TWS 32448 17,5 Charr. ■ Kanal I Channel = 5 Charr.

Visual obturator with instrument channel for HYBRID resectoscopy outer sheath



TWS 32449 19 Charr.

TWS 32450 24 Charr.

HYBRID Monopolar working element, passive cutting, single stem, closed handle





TWS 32451 19 Charr.

TWS 32452 24 Charr.

HYBRID working element, active cutting, single stem, closed handle



! Packing unit = 5 pieces



TWS 32453 19 Charr. 
TWS 32454 24 Charr. 
TWS 32455 24 Charr. PI 



Loop electrode, 30° angled



TWS 32456 19 Charr. 
TWS 32457 24 Charr. 



Loop electrode, straight



TWS 32458 19 Charr. 
TWS 32459 24 Charr. 

Loop electrode, 90° angled,
for 0° endoscopes



TWS 32460 19 Charr. 
TWS 32461 24 Charr. 



Knife electrode, 90° angled



TWS 32462 24 Charr. 



Cone electrode



TWS 32463 19 Charr. 
TWS 32464 24 Charr. 

Ball electrode, Ø 3.0 mm



TWS 32465 19 Charr. 
TWS 32467 24 Charr. 

Roller electrode, smooth, Ø 3.0 mm



TWS 32468 24 Charr. 

Vaporisation electrode, serrated, Ø 3.0 mm



TWS 32469 24 Charr. 

Vaporisation electrode, serrated, Ø 5.0 mm



TWS 32470

Sterilisation tube for resectoscopy electrodes

! Packing unit = 5 pieces



TWS 32471 24 Charr. 

Vaporisation electrode, blunt



TWS 32472 24 Charr. 

Vaporisation electrode, blunt with slot



TWS 32473 24 Charr. 

Vaporisation electrode, convex



TWS 32474 24 Charr.

Vaporisation electrode, with grooves, convex

Resectoscopy sheaths

Resectoscopy continuous flow sheaths with 2 stopcocks, **fixed inner sheath**, surround perforation



Size	Colour code	Complete with obturator	Inner sheath, only	Outer sheath, only	Obturator, only
22 Charr.	<input type="checkbox"/>	TWS 32475	TWS 32478 19 Charr.	TWS 32481	TWS 32484
26 Charr.	<input type="checkbox"/>	TWS 32476	TWS 32479 24 Charr.	TWS 32482	TWS 32485
28,5 Charr.	<input type="checkbox"/>	TWS 32477	TWS 32480 27 Charr.	TWS 32483	TWS 32486

Resectoscopy continuous flow sheaths with 2 stopcocks, **rotatable inner sheath**, surround perforation



Size	Colour code	Complete with obturator	Inner sheath, only	Outer sheath, only	Obturator, only
22 Charr.	<input type="checkbox"/>	TWS 32487	TWS 32490 19 Charr.	TWS 32493	TWS 32496
26 Charr.	<input type="checkbox"/>	TWS 32488	TWS 32491 24 Charr.	TWS 32494	TWS 32497
28,5 Charr.	<input type="checkbox"/>	TWS 32489	TWS 32492 27 Charr.	TWS 32495	TWS 32498

Treasure Wright (U.K.) Ltd.



- TWS 32499** 19 Charr.
- TWS 32500** 24 Charr.
- TWS 32501** 27 Charr.

Standard obturator for resectoscopy sheaths



- TWS 32502** 19 Charr.
- TWS 32503** 24 Charr.
- TWS 32504** 27 Charr.

Visual obturator for resectoscopy sheaths



- TWS 32505** 24 Charr. Kanal I Channel = 5 Charr.
- TWS 32506** 27 Charr. Kanal I Channel = 7 Charr.

Visual obturator with instrument channel for resectoscopy sheaths





- TWS 32508** 24 Charr.
- TWS 32507** 27 Charr.

Deflecting obturator for resectoscopy sheaths

Monopolar and bipolar connecting cables



Monopolar connecting cables with round plug

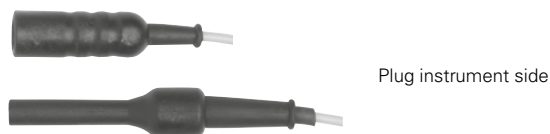

	Length	Item number
 Ø 4 mm	3,0 m	TWS 32510
	5,0 m	TWS 32511
 Ø 5 mm	3,0 m	TWS 32512
	5,0 m	TWS 32513
 Ø 8 mm	3,0 m	TWS 32514
	5,0 m	TWS 32515

Bipolar connecting cables with two round plugs



	Length	Item number
 28,2 mm	3,0 m	TWS 32516
 Ø 7,8 mm	3,0 m	TWS 32517
 Ø 12,3 mm	3,0 m	TWS 32518

Treasure Wright (U.K.) Ltd.

Laser Cysto-Urethroscope sheath



Laser Cysto-Urethroscope sheath with 2 fixed stopcocks for continuous flow, QUICK-LOCK connection



QUICK-LOCK

Size	For scopes	Colour code	Complete with obturator	Sheath, only	Obturator, only
23 Charr.	Ø 4,0 mm, 30°	■	TWS 32519 C	TWS 32520	TWS 32521



QUICK-LOCK

TWS 32522

Visual obturator for 23 Charr. Laser Cysto-Urethroscope sheath, **for 30° Endoscopes**, QUICK-LOCK connection



QUICK-LOCK

TWS 32523

Visual obturator for 23 Charr. Laser Cysto-Urethroscope sheath, 8 Charr. instrument channel, **for 30° Endoscopes**, QUICK-LOCK connection

Treasure Wright (U.K.) Ltd.

128-160 City Road, London, EC1V 2NX, United Kingdom
 info@twrightmedical.com



TWS 32524

TWS 32525

Working element for laser probes up to \varnothing 0.8 mm, passive cutting, closed handle

TWS 32526

TWS 32527

Working element for laser probes up to \varnothing 1.2 mm, passive cutting, closed handle



QUICK-LOCK

TWS 32528

Working element for laser probes up to \varnothing 0.8 mm, passive cutting, 17,5 Charr., closed handle



Guiding tube lock

TWS 32529

Working element for laser probes, with exchangeable guiding tubes, passive cutting, closed handle, for endoscopes Ø 4 mm, 12°, 30°

Exchangeable guiding tubes for laser probes



Ø

Laser probe



0,8 mm	TWS 32530	TWS 32534
1,0 mm	TWS 32531	TWS 32535
1,2 mm	TWS 32532	TWS 32536
1,4 mm	TWS 32533	TWS 32537

mit Retraktor
with retractor



TWS 32538

Adapter for laser probes, short



TWS 32539

Adapter for laser probes, long





TWS 32540

Tuohy Borst adapter, Luer-Lock connection

Resectoscopy sheaths for Laser working elements

Resectoscopy continuous flow sheath with 2 stopcocks, **rotatable inner sheath**, surround perforation



Size	Colour code	Complete with obturator	Inner sheath, only	Outer sheath, only	Obturator, only
22 Charr.		TWS 32541	TWS 32547 19 Charr.	TWS 32543	TWS 32545
26 Charr.		TWS 32542	TWS 32548 24 Charr.	TWS 32544	TWS 32546

Resectoscopy continuous flow sheath with 2 stopcocks, **rotatable inner sheath**, surround perforation

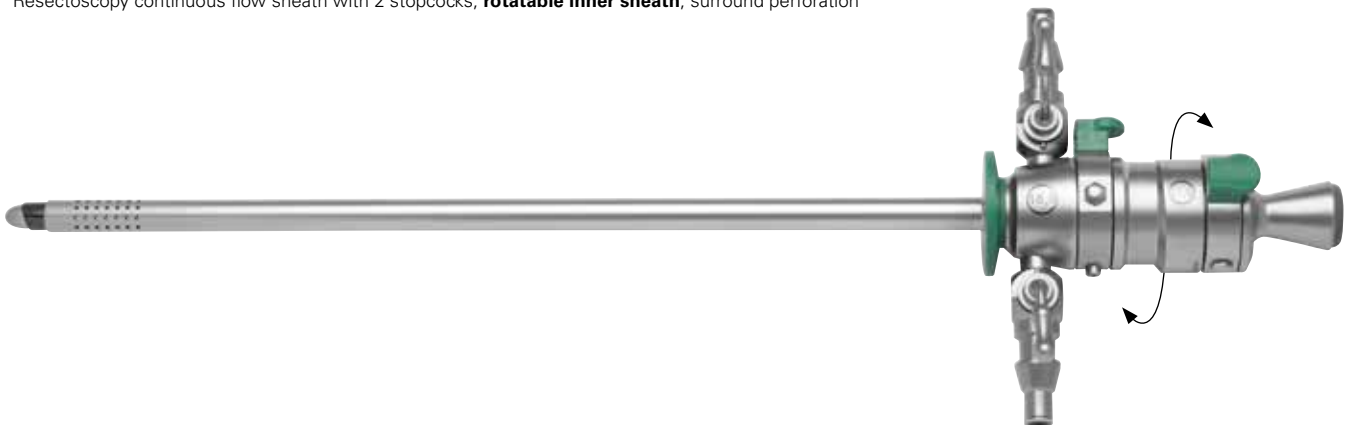

QUICK-LOCK

Size	Colour code	Complete with obturator	Inner sheath, only	Outer sheath, only	Obturator, only
18,5 Charr.		TWS 32549	TWS 32550 17,5 Charr.	TWS 32551	TWS 32552

Treasure Wright (U.K.) Ltd.



TWS 32553 19 Charr.

TWS 32554 24 Charr.

Standard obturator for resectoscopy sheaths



TWS 32555 19 Charr.

TWS 32556 24 Charr.

Visual obturator for resectoscopy sheaths



TWS 32557 24 Charr. Kanal I Channel = 5 Charr.

Visual obturator with instrument channel for resectoscopy sheaths



QUICK-LOCK

TWS 32558 17,5 Charr.

Standard obturator for Mini HYBRID resectoscopy sheath



QUICK-LOCK

TWS 32559 17,5 Charr. Kanal I Channel = 5 Charr.

Visual obturator with instrument channel for HYBRID resectoscopy outer sheath

Endoscope for morcellation, Tissue punch



TW Surgical

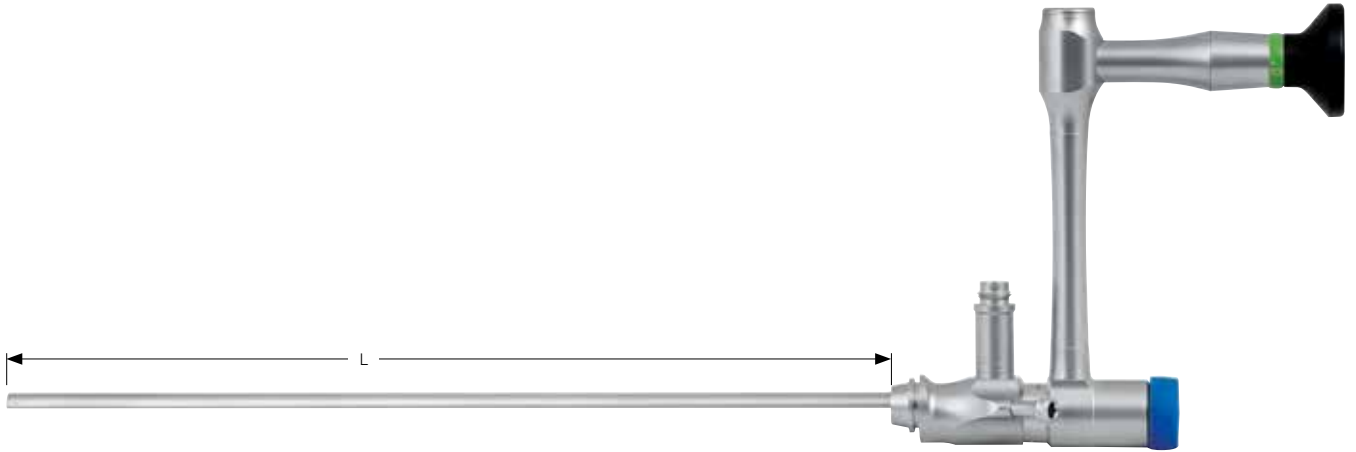

HD MORC

Length	Ø	Instrument channel	0°	15°
250,0 mm	19 Charr.	Ø 5,0 mm / 15 Charr.	<input checked="" type="checkbox"/>	<input type="checkbox"/>

Nephroscope, 90° angled ocular, instrument channel



TWS 32563

Adapter for Nephroscopes for use with 26 Charr. resectoscopy outer sheaths



TWS 32562

Luer-Lock male, rotating, with stopcock and Luer-Lock female

Endoscope, mounted on resectoscopy outer sheath

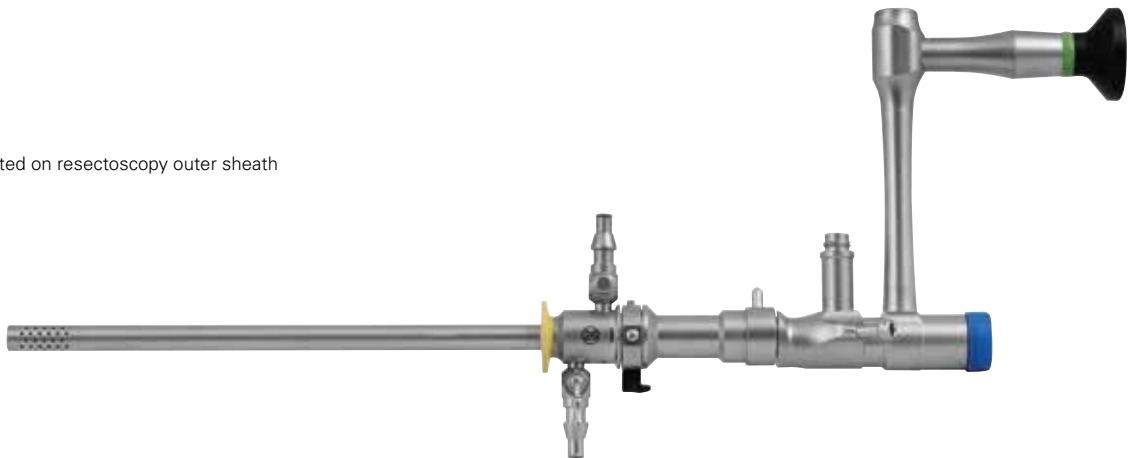

Treasure Wright (U.K.) Ltd.

128-160 City Road, London, EC1V 2NX, United Kingdom
info@twrightmedical.com

4K
ULTRAHD

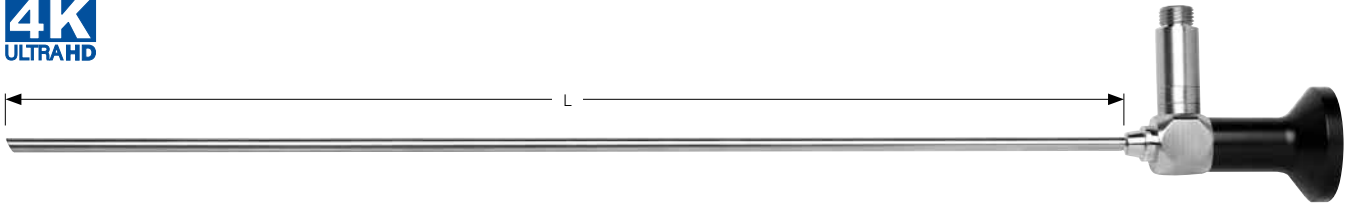

4K CYST

0°

Length	Ø	
300,0 mm	2,9 mm	TWS 32564 UHD
300,0 mm	4,0 mm	TWS 32565 UHD

3-Shaft Endoscope

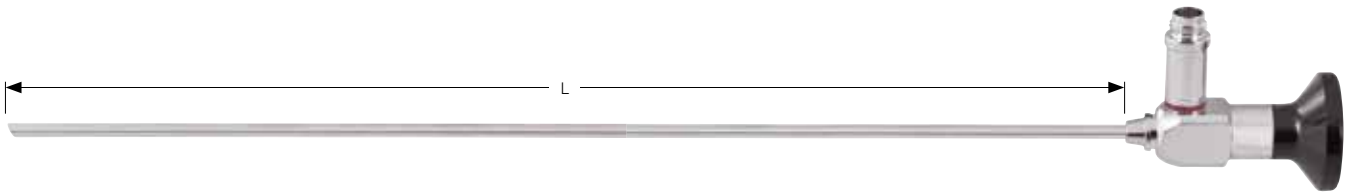

HD CYST

0°

Length	Ø	
302,0 mm	2,9 mm	TWS 32566 ■
302,0 mm	4,0 mm	TWS 32567 ■

Scale 10 mm

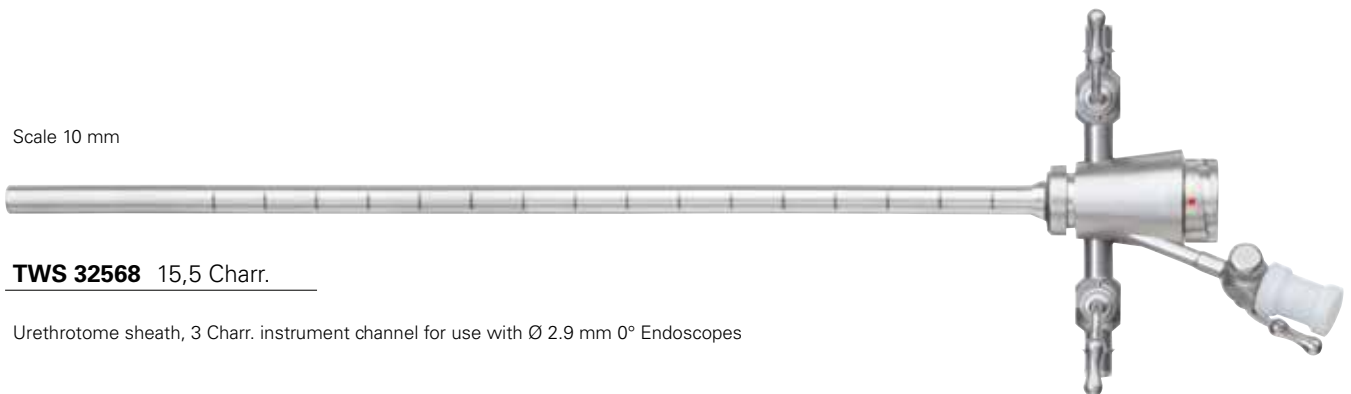

TWS 32568 15,5 Charr.

Urethrotome sheath, 3 Charr. instrument channel for use with Ø 2.9 mm 0° Endoscopes



TWS 32569 15,5 Charr.

Standard obturator for 15.5 Charr. Urethrotome sheath

! Not to use with HF-Current



TWS 32570 15,5 Charr.

Telescope bridge with 5 Charr. instrument channel for 15.5 Charr. Urethrotome sheath



TWS 32571 15,5 Charr.

Working element, passive cutting, single stem, closed handle

! Not to use with HF-Current



TWS 32572 15,5 Charr.

Knife, straight



TWS 32573 15,5 Charr.

Knife, straight, wave cut



TWS 32574 15,5 Charr.

Knife, hook shaped



TWS 32575

Sterilisation tube for cold knives

Scale 10 mm

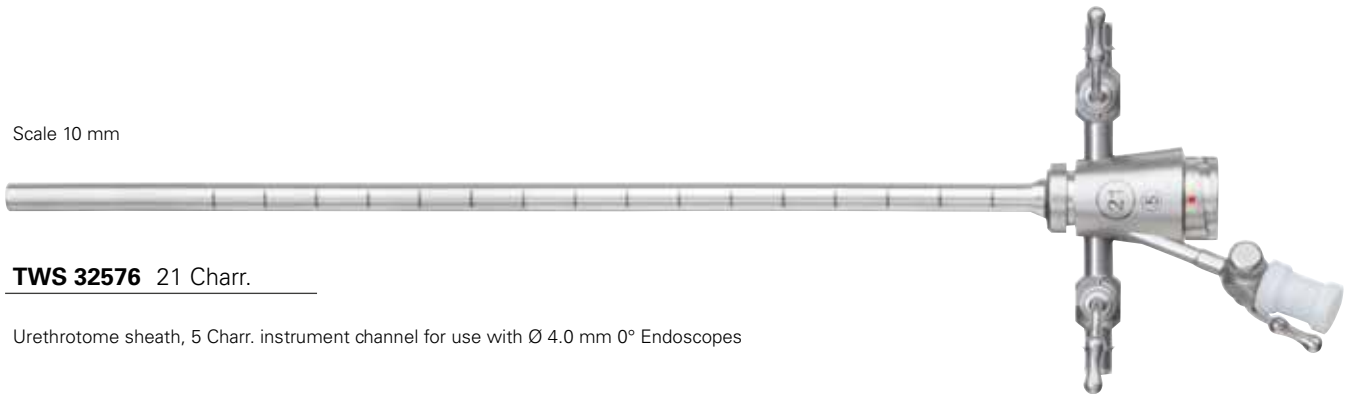

TWS 32576 21 Charr.

Urethrotome sheath, 5 Charr. instrument channel for use with Ø 4.0 mm 0° Endoscopes



TWS 32577 21 Charr.

Standard obturator for 21 Charr. Urethrotome sheath



TWS 32578 21 Charr.

Obturator with 5 Charr. instrument channel for 21 Charr. Urethrotome sheath



TWS 32579 21 Charr.

Visual obturator for 21 Charr. Urethrotome sheath



TWS 32580 21 Charr.

Sheath for insertion of balloon catheter, laterally open, for 21 Charr. Urethrotome sheath



TWS 32581 21 Charr.

Telescope bridge with 5 Charr. instrument channel for 21 Charr. Urethrotome sheath



TWS 32582 21 Charr.

Sheath for continuous flow for 21 Charr. Urethrotome sheath

! Not to use with HF-Current



TWS 32583 24 Charr.

Working element, passive cutting, single stem, closed handle

! Not to use with HF-Current



TWS 32584 21 Charr.

Knife, straight



TWS 32585 21 Charr.

Knife, round



TWS 32586 21 Charr.

Knife, straight, wave cut



TWS 32587 21 Charr.

Knife, hook shaped



TWS 32588

Sterilisation tube for cold knives

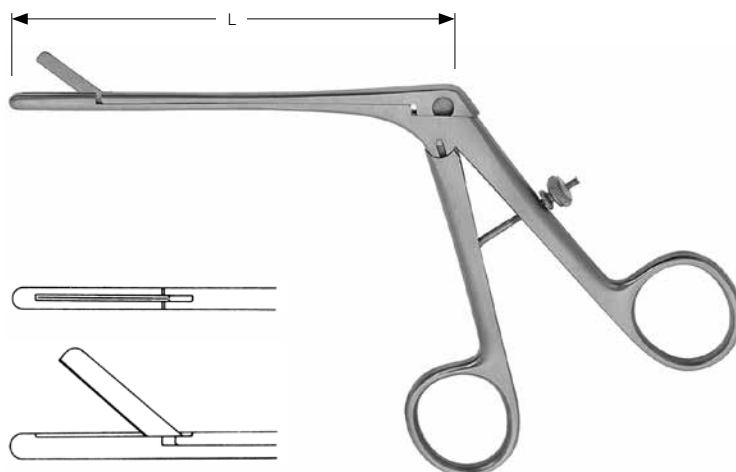

SACHSE

TWS 32589 12,5 cm, 4 3/4"

Meatotome, Cutting size 10 - 36 Charr.



OTIS

TWS 32590 SET

consisting of:

1 Dilator	TWS 32596
2 Knives	TWS 32597
1 Tip, conical	TWS 32598
1 Tip, flat	TWS 32599
1 Tip, ball	TWS 32600



TWS 32601

Tip, conical



TWS 32602

Tip, flat



TWS 32603

Tip, ball



TWS 32604

Knife



TWS 32605

Dilator

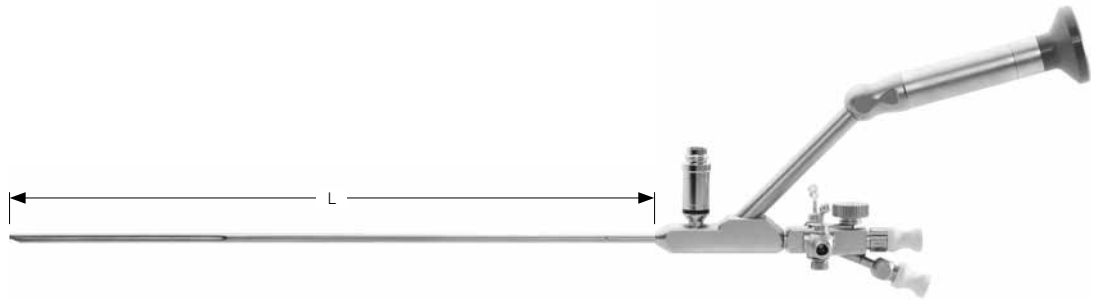

HD URS

12°

Length	Ø	For instruments	
315,0 mm	6,0 7,5 Fr.	1 x 4 Fr. 2 x 2,4 Fr.	TWS 32606 ■
315,0 mm	8,0 9,8 Fr.	1 x 5 Fr. 2 x 3,0 Fr.	TWS 32607 ■
315,0 mm	8,5 11,5 Fr.	1 x 6 Fr. 2 x 4,0 Fr.	TWS 32608 ■

Uretero-Renoscope, offset eyepiece, 2 instrument channels



HD URS

12°

Length	Ø	For instruments	
430,0 mm	6,0 7,5 Fr.	1 x 4 Fr. 2 x 2,4 Fr.	TWS 32609 ■
430,0 mm	8,0 9,8 Fr.	1 x 5 Fr. 2 x 3,0 Fr.	TWS 32610 ■
430,0 mm	8,5 11,5 Fr.	1 x 6 Fr. 2 x 4,0 Fr.	TWS 32611 ■

Uretero-Renoscope, offset eyepiece, 2 instrument channels

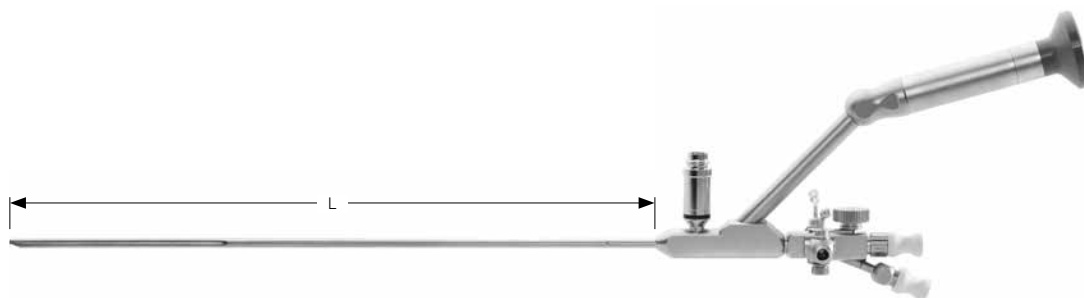

HD URS

6°

Length	Ø	For instruments		
315,0 mm	6,0 7,5 Fr.	1 x 4 Fr. 2 x 2,4 Fr.	TWS 32612	■
315,0 mm	8,0 9,8 Fr.	1 x 5 Fr. 2 x 3,0 Fr.	TWS 32613	■
315,0 mm	8,5 11,5 Fr.	1 x 6 Fr. 2 x 4,0 Fr.	TWS 32614	■

Uretero-Renoscope, offset eyepiece, 2 instrument channels



HD URS

6°

Length	Ø	For instruments		
430,0 mm	6,0 7,5 Fr.	1 x 4 Fr. 2 x 2,4 Fr.	TWS 32615	■
430,0 mm	8,0 9,8 Fr.	1 x 5 Fr. 2 x 3,0 Fr.	TWS 32616	■
430,0 mm	8,5 11,5 Fr.	1 x 6 Fr. 2 x 4,0 Fr.	TWS 32617	■

Uretero-Renoscope, offset eyepiece, 2 instrument channels

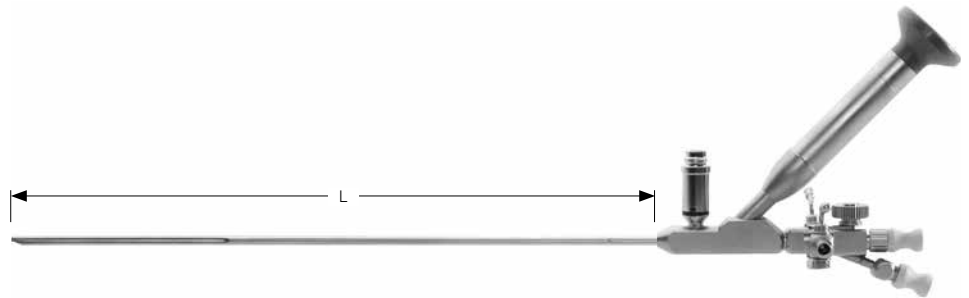

HD URS

12°

Length	Ø	For instruments	
315,0 mm	6,0 7,5 Fr.	1 x 4 Fr. 2 x 2,4 Fr.	TWS 32618 ■
315,0 mm	8,0 9,8 Fr.	1 x 5 Fr. 2 x 3,0 Fr.	TWS 32619 ■
315,0 mm	8,5 11,5 Fr.	1 x 6 Fr. 2 x 4,0 Fr.	TWS 32620 ■

Uretero-Renoscope, oblique eyepiece, 2 instrument channels

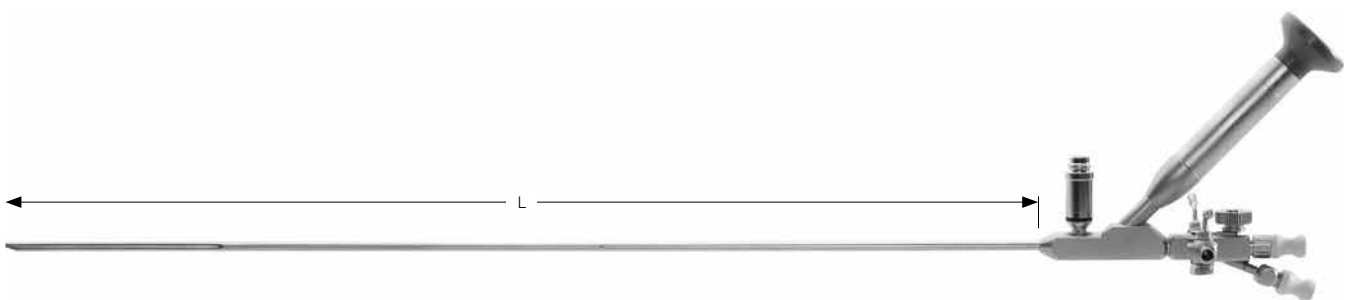

HD URS

12°

Length	Ø	For instruments	
430,0 mm	6,0 7,5 Fr.	1 x 4 Fr. 2 x 2,4 Fr.	TWS 32621 ■
430,0 mm	8,0 9,8 Fr.	1 x 5 Fr. 2 x 3,0 Fr.	TWS 32622 ■
430,0 mm	8,5 11,5 Fr.	1 x 6 Fr. 2 x 4,0 Fr.	TWS 32623 ■

Uretero-Renoscope, oblique eyepiece, 2 instrument channels

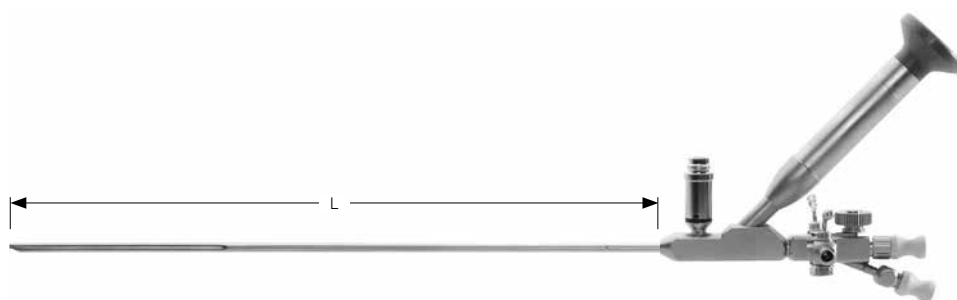

HD URS

6°

Length	Ø	For instruments	
315,0 mm	6,0 7,5 Fr.	1 x 4 Fr. 2 x 2,4 Fr.	TWS 32624 ■
315,0 mm	8,0 9,8 Fr.	1 x 5 Fr. 2 x 3,0 Fr.	TWS 32625 ■
315,0 mm	8,5 11,5 Fr.	1 x 6 Fr. 2 x 4,0 Fr.	TWS 32626 ■

Uretero-Renoscope, oblique eyepiece, 2 instrument channels

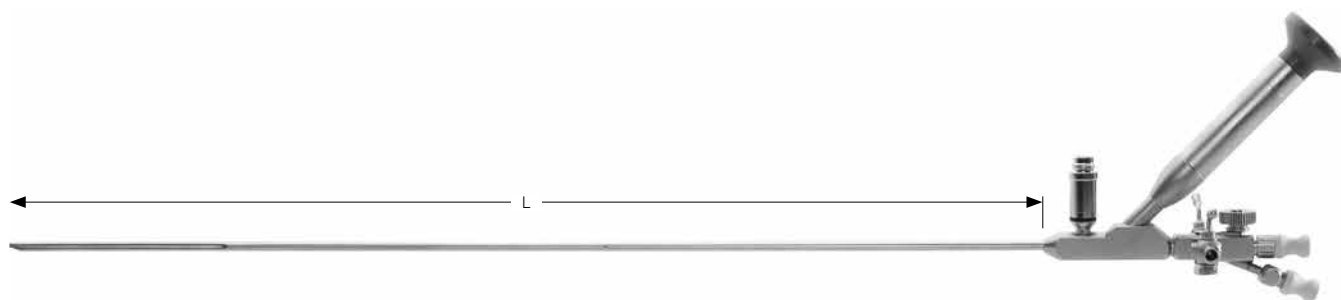

HD URS

6°

Length	Ø	For instruments	
430,0 mm	6,0 7,5 Fr.	1 x 4 Fr. 2 x 2,4 Fr.	TWS 32627 ■
430,0 mm	8,0 9,8 Fr.	1 x 5 Fr. 2 x 3,0 Fr.	TWS 32628 ■
430,0 mm	8,5 11,5 Fr.	1 x 6 Fr. 2 x 4,0 Fr.	TWS 32629 ■

Uretero-Renoscope, oblique eyepiece, 2 instrument channels

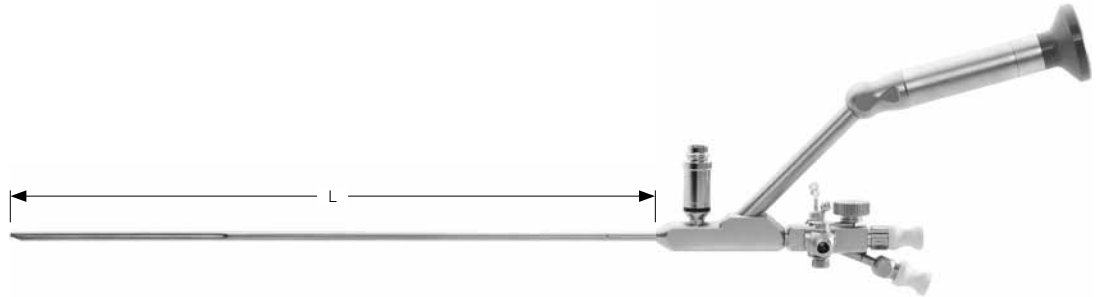

HD URS

Length	Ø	For instruments	5°		6°	
315,0 mm	4,5 6,5 Fr.	1 x 3 Fr.	TWS 32630	■	TWS 32632	■
430,0 mm	4,5 6,5 Fr.	1 x 3 Fr.	TWS 32631	■	TWS 32633	■

Uretero-Renoscope, offset eyepiece, 1 instrument channel

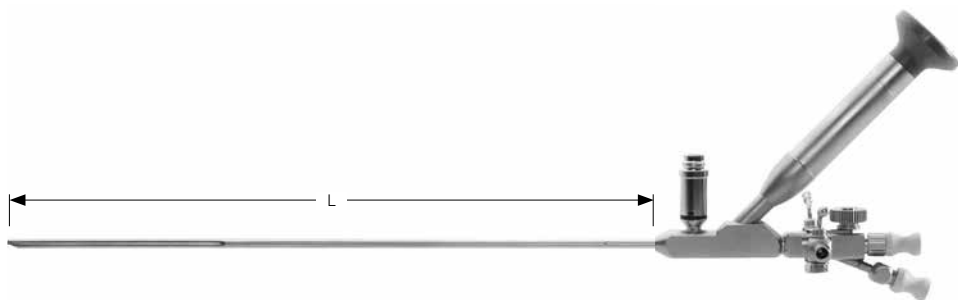

HD URS

Length	Ø	For instruments	5°		6°	
315,0 mm	4,5 6,5 Fr.	1 x 3 Fr.	TWS 32634	■	TWS 32636	■
430,0 mm	4,5 6,5 Fr.	1 x 3 Fr.	TWS 32635	■	TWS 32637	■

Uretero-Renoscope, oblique eyepiece, 1 instrument channel



TWS 32638

Cleaning brush for instrument channel, flexible

! Illustration: Adapter mounted on instrument bridge



TWS 32639

Adapter for EMS Lithotripter



TWS 32640

Automatic valve for instrument bridge, silicone



TWS 32641

Spare sealing cap for URS instrument bridge

Sterilization baskets for Uretero-Renoscope, with lid

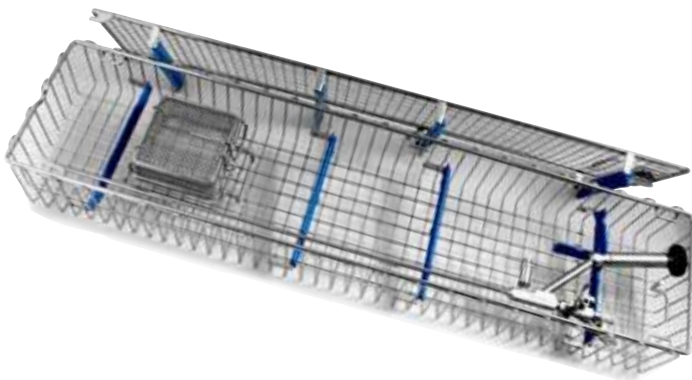

TWS 32642 580 x 160 x 52 mm

Suitable for URS with working length **315 mm**

TWS 32643 640 x 150 x 77 mm

Suitable for URS with working length **430 mm**

! Delivery without endoscope







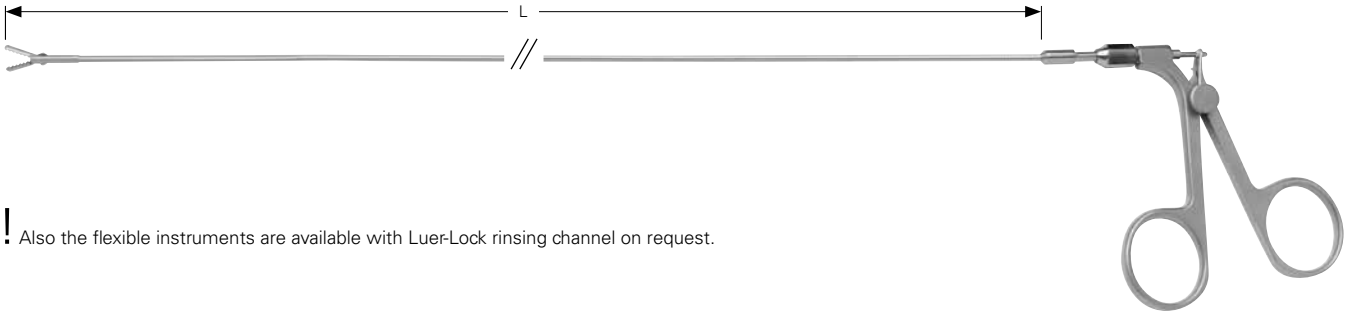

Flexible and Semi-rigid instruments for Uretero-Renoscopy



TW Surgical



! Also the flexible instruments are available with Luer-Lock rinsing channel on request.

	Version	Ø	Length	Flexible	Semi-rigid
	Alligator Grasping forceps, double action	3 Charr.	600 mm	TWS 32644	TWS 32645
	Stone grasping forceps, double action	4 Charr.	600 mm	TWS 32646	TWS 32648
		5 Charr.	600 mm	TWS 32647	TWS 32649
	Alligator Grasping forceps, double action	4 Charr.	600 mm	TWS 32650	TWS 32652
		5 Charr.	600 mm	TWS 32651	TWS 32653
	Grasping forceps for larger stones and fragments, double action	4 Charr.	600 mm	TWS 32654	TWS 32656
		5 Charr.	600 mm	TWS 32655	TWS 32657
	Grasping forceps for Steinstrasse, double action	4 Charr.	600 mm	TWS 32658	TWS 32660
		5 Charr.	600 mm	TWS 32659	TWS 32661
	Biopsy forceps, spoon oval, double action	3 Charr.	600 mm	TWS 32662	TWS 32665
		4 Charr.	600 mm	TWS 32663	TWS 32666
		5 Charr.	600 mm	TWS 32664	TWS 32667
	Scissors, blunt, single action	3 Charr.	600 mm	TWS 32668	TWS 32671
		4 Charr.	600 mm	TWS 32669	TWS 32673
		5 Charr.	600 mm	TWS 32670	TWS 32672
	Uretero-slitting scissors, retrograde (upwards) cutting, single action	4 Charr.	600 mm		TWS 32674
		5 Charr.	600 mm		TWS 32675

Other lengths, diameters and jaw parts available on request.

Treasure Wright (U.K.) Ltd.

128-160 City Road, London, EC1V 2NX, United Kingdom
info@twrightmedical.com

Semi-rigid instruments with Luer-Lock rinsing channel for Uretero-Renoscropy



TW Surgical



	Version	Ø	Length	Semi-rigid
	Alligator Grasping forceps, double action	3 Charr.	600 mm	TWS 32676 LL
	Stone grasping forceps, double action	4 Charr.	600 mm	TWS 32677 LL
		5 Charr.	600 mm	TWS 32678 LL
	Alligator Grasping forceps, double action	4 Charr.	600 mm	TWS 32679 LL
		5 Charr.	600 mm	TWS 32680 LL
	Grasping forceps for larger stones and fragments, double action	4 Charr.	600 mm	TWS 32681 LL
		5 Charr.	600 mm	TWS 32682 LL
	Grasping forceps for Steinstrasse, double action	4 Charr.	600 mm	TWS 32686 LL
		5 Charr.	600 mm	TWS 32687 LL
	Biopsy forceps, spoon oval, double action	3 Charr.	600 mm	TWS 32683 LL
		4 Charr.	600 mm	TWS 32684 LL
		5 Charr.	600 mm	TWS 32685 LL
	Scissors, blunt, single action	3 Charr.	600 mm	TWS 32688 LL
		4 Charr.	600 mm	TWS 32689 LL
		5 Charr.	600 mm	TWS 32690 LL
	Uretero-slitting scissors, retrograde (upwards) cutting, single action	4 Charr.	600 mm	TWS 32691 LL
		5 Charr.	600 mm	TWS 32692 LL

Other lengths, diameters and jaw parts available on request.

Treasure Wright (U.K.) Ltd.

128-160 City Road, London, EC1V 2NX, United Kingdom
 info@twrightmedical.com

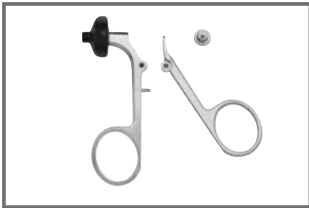
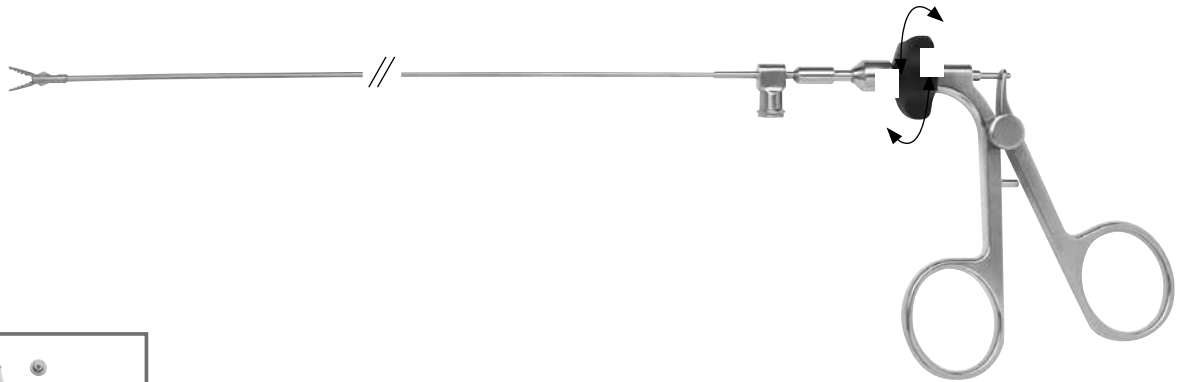

Stainless steel handle can be easily removed and detached for better cleaning.



Integrated overload protection for a significantly longer service life.

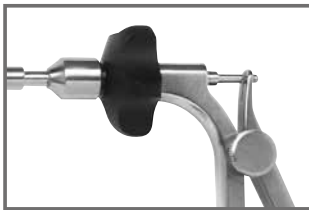

360° rotatable shaft is smoothly to adjust and with a haptic feedback while rotating.

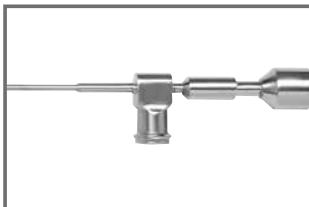







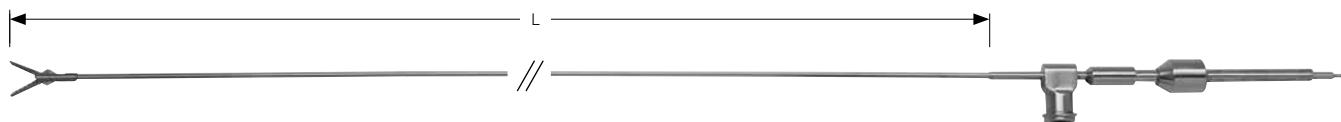

Cleaning port Luer-Lock for an easier and faster cleaning without removing the handle.

TWS 32693 MH

HyONE Handle with rotating wheel and overload protection, stainless steel





	Version	Ø	Length	Insert, only	Complete with handle
	Alligator Grasping forceps, double action	3 Charr.	600 mm	TWS 326943 MI	TWS 32695 MC
	Stone grasping forceps, double action	4 Charr.	600 mm	TWS 32696 MI	TWS 32698 MC
		5 Charr.	600 mm	TWS 32697 MI	TWS 32699 MC
	Alligator Grasping forceps, double action	4 Charr.	600 mm	TWS 32700 MI	TWS 32702 MC
		5 Charr.	600 mm	TWS 32701 MI	TWS 32703 MC
	Grasping forceps for larger stones and fragments, double action	4 Charr.	600 mm	TWS 32704 MI	TWS 32706 MC
		5 Charr.	600 mm	TWS 32705 MI	TWS 32707 MC
	Grasping forceps for Steinstrasse, double action	4 Charr.	600 mm	TWS 32712 MI	TWS 32710 MC
		5 Charr.	600 mm	TWS 32713 MI	TWS 32711 MC
	Biopsy forceps, spoon oval, double action	3 Charr.	600 mm	TWS 32716 MI	TWS 32717 MC
		4 Charr.	600 mm	TWS 32714 MI	TWS 32718 MC
		5 Charr.	600 mm	TWS 32715 MI	TWS 32719 MC
	Scissors, blunt, single action	3 Charr.	600 mm	TWS 32720 MI	TWS 32723 MC
		4 Charr.	600 mm	TWS 32721 MI	TWS 32724 MC
		5 Charr.	600 mm	TWS 32722 MI	TWS 32725 MC
	Uretero-slitting scissors, retrograde (upwards) cutting, single action	4 Charr.	600 mm	TWS 32726 MI	TWS 32728 MC
		5 Charr.	600 mm	TWS 32727 MI	TWS 32729 MC

Other lengths, diameters and jaw parts available on request.

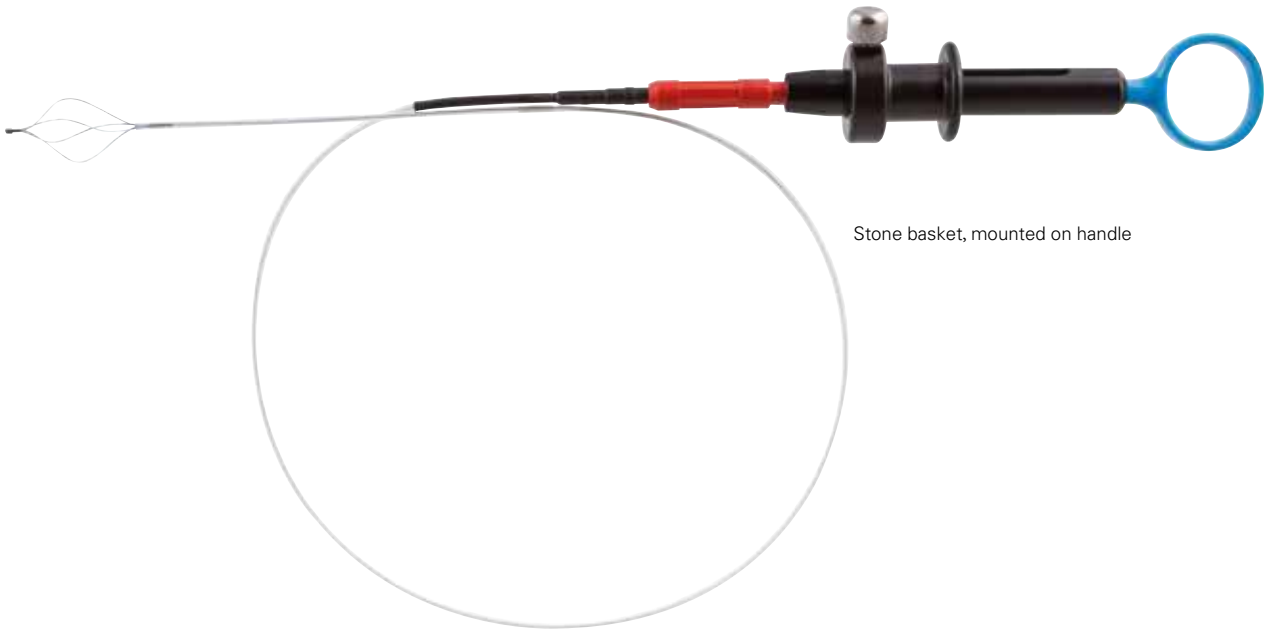

Stone basket, mounted on handle



TWS 32730 3 / 5 Charr.

Handle for stone basket, single-use

Stone dislodger with basket, single-use



Size	Working length	Wires	4	Wires	5	Wires	6
3 Charr.	900 mm	TWS 32731					
3 Charr.	1200 mm	TWS 32732					
5 Charr.	600 mm	TWS 32733		TWS 32734		TWS 32735	



HD NEPHRO

Length	Ø	Instrument channel	0°	15°
200,0 mm	19 Charr.	Ø 5,0 mm 15 Charr.	<input checked="" type="checkbox"/>	<input type="checkbox"/>
250,0 mm	19 Charr.	Ø 5,0 mm 15 Charr.	<input checked="" type="checkbox"/>	<input type="checkbox"/>

Nephroscope, 45° angled ocular, instrument channel



TWS 32740 Ø 6,1 mm

Adapter for Nephroscopes

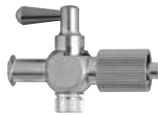

TWS 32741

Luer-Lock male, rotating, with stopcock and Luer-Lock female

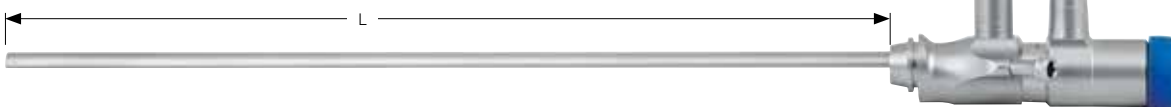

HD NEPHRO

Length	Ø	Instrument channel	0°	15°
200,0 mm	19 Charr.	Ø 5,0 mm 15 Charr.	<input checked="" type="checkbox"/>	<input type="checkbox"/>
250,0 mm	19 Charr.	Ø 5,0 mm 15 Charr.	<input checked="" type="checkbox"/>	<input type="checkbox"/>

Nephroscope, 90° angled ocular, instrument channel



TWS 32746

Spare sealing cap for adapter



TWS 32747

Spare sealing cap for OP-Laparoscopes and Nephroscopes

Nephroscopy sheaths for continuous flow with 1 fixed stopcock

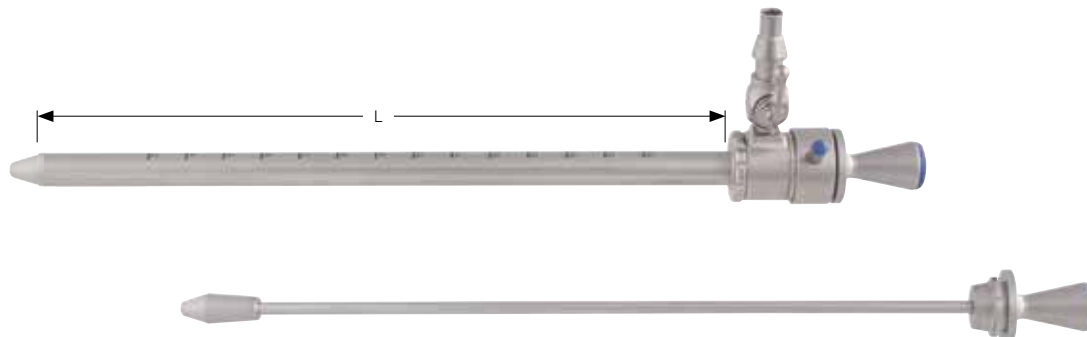

Size	Working length	Colour code	Complete with obturator	Sheath, only	Obturator, only
24 Charr.	200,0 mm	■	TWS 32748	TWS 32750	TWS 32752
26 Charr.	200,0 mm	■	TWS 32749	TWS 32751	TWS 32753

Nephroscopy sheaths for continuous flow with 1 rotatable stopcock

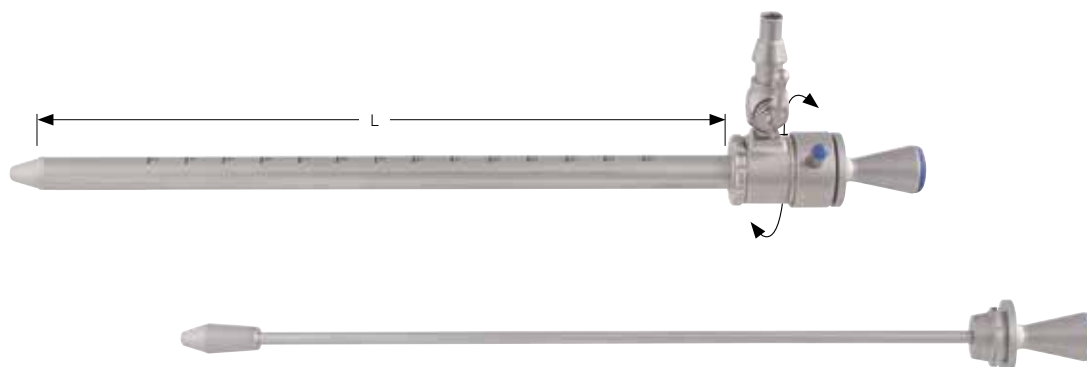



Size	Working length	Colour code	Complete with obturator	Sheath, only	Obturator, only
24 Charr.	200,0 mm	■	TWS 32754	TWS 32758	TWS 32762
26 Charr.	200,0 mm	■	TWS 32755	TWS 32759	TWS 32763
24 Charr.	250,0 mm	■	TWS 32756	TWS 32760	TWS 32764
26 Charr.	250,0 mm	■	TWS 32757	TWS 32761	TWS 32765

Nephroscopy sheaths

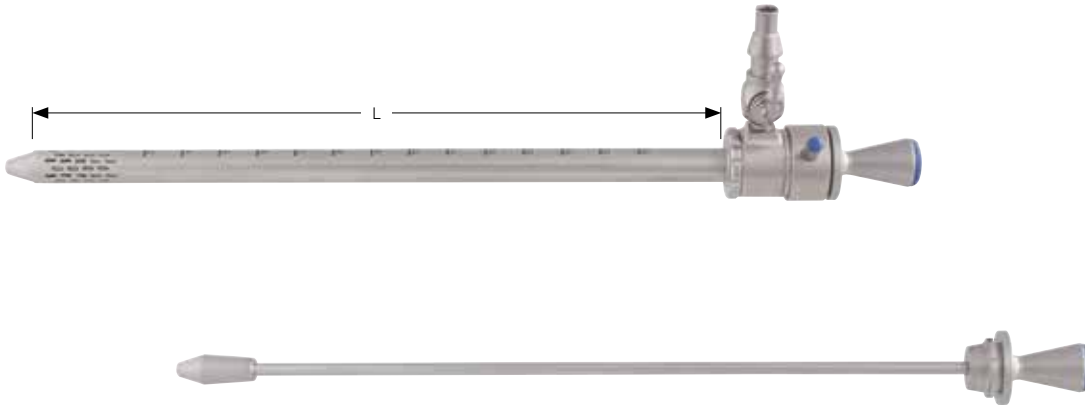

Nephroscopy sheaths with distal continuous flow with 1 fixed stopcock

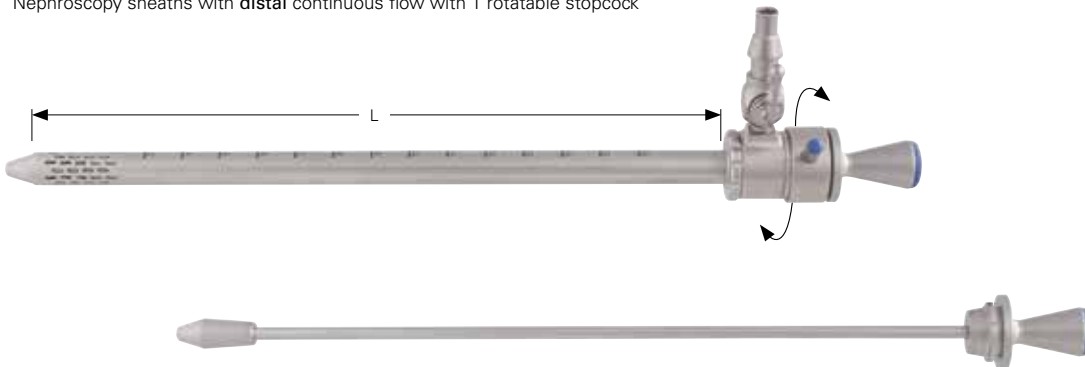

Size	Working length	Colour code	Complete with obturator	Sheath, only	Obturator, only
26 Charr.	200,0 mm		TWS 32766	TWS 32768	TWS 32770
26 Charr.	250,0 mm		TWS 32767	TWS 32769	TWS 32771

Nephroscopy sheaths with distal continuous flow with 1 rotatable stopcock



Size	Working length	Colour code	Complete with obturator	Sheath, only	Obturator, only
26 Charr.	200,0 mm		TWS 32772	TWS 32774	TWS 32776
26 Charr.	250,0 mm		TWS 32773	TWS 32775	TWS 32777



TWS 32778 9 - 24 Charr.

Set telescope bougies, consisting of 6 dilation sleeves 9 / 12 / 15 / 18 / 21 / 24 Charr. and 1 pc. each rigid / flexible guide probe



TWS 32779 9 Charr.

TWS 32780 12 Charr.

TWS 32781 15 Charr.

TWS 32782 18 Charr.

TWS 32783 21 Charr.

TWS 32784 24 Charr.

TWS 32785 27 Charr.

TWS 32786 30 Charr.

Dilation sleeve



TWS 32787

Guide probe, rigid



TWS 32788

Guide probe, flexible



TWS 32789

Adapter for Nephroscopes for use with resectoscopy outer sheaths

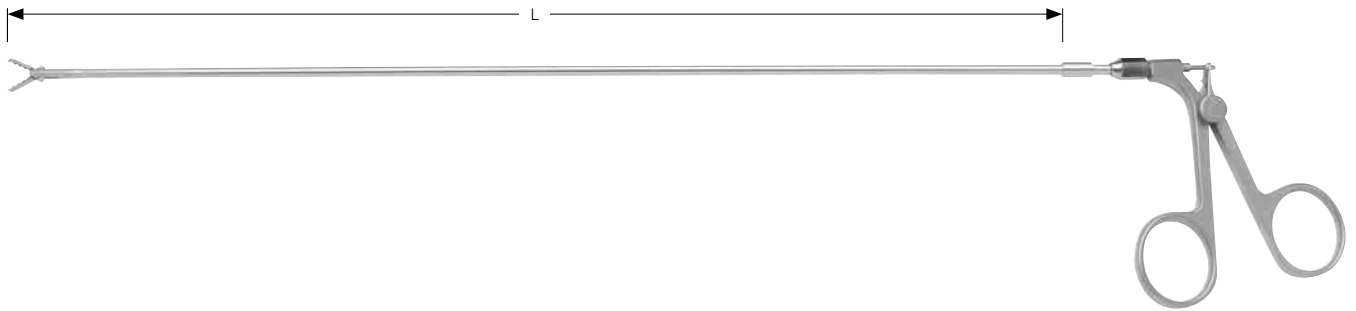

Ausführung Version	Ø	Länge Length	Starr Rigid
Grasping forceps for larger stones & fragments, fenestrated	10 Charr.	330 mm	TWS 32790
	10 Charr.	360 mm	TWS 32791
	10 Charr.	380 mm	TWS 32792
	10 Charr.	420 mm	TWS 32793



Grasping forceps for larger stones & fragments, toothed	10 Charr.	330 mm	TWS 32794
	10 Charr.	360 mm	TWS 32795
	10 Charr.	380 mm	TWS 32796
	10 Charr.	420 mm	TWS 32797







Biopsy forceps, spoon oval	10 Charr.	330 mm	TWS 32798
	10 Charr.	360 mm	TWS 32799
	10 Charr.	380 mm	TWS 32800
	10 Charr.	420 mm	TWS 32801



Micro scissors, pointed	10 Charr.	330 mm	TWS 32802
	10 Charr.	360 mm	TWS 32803
	10 Charr.	380 mm	TWS 32804
	10 Charr.	420 mm	TWS 32805

Other lengths, diameters and jaw parts available on request.



	Version	Ø	Length	Rigid
		10 Charr.	330 mm	TWS 32806 LL
		10 Charr.	360 mm	TWS 32807 LL
	Grasping forceps for larger stones & fragments, fenestrated	10 Charr.	380 mm	TWS 32808 LL
		10 Charr.	420 mm	TWS 32809 LL
		10 Charr.	330 mm	TWS 32810 LL
		10 Charr.	360 mm	TWS 32811 LL
	Grasping forceps for larger stones & fragments, toothed	10 Charr.	380 mm	TWS 32812 LL
		10 Charr.	420 mm	TWS 32813 LL
		10 Charr.	330 mm	TWS 32814 LL
		10 Charr.	360 mm	TWS 32815 LL
	Biopsy forceps, spoon oval	10 Charr.	380 mm	TWS 32816 LL
		10 Charr.	420 mm	TWS 32817 LL
		10 Charr.	330 mm	TWS 32818 LL
		10 Charr.	360 mm	TWS 32819 LL
	Micro scissors, pointed	10 Charr.	380 mm	TWS 32820 LL
		10 Charr.	420 mm	TWS 32821 LL

Other lengths, diameters and jaw parts available on request.

Nephroscopy triple jaw grasper with Luer-Lock rinsing channel



TW Surgical

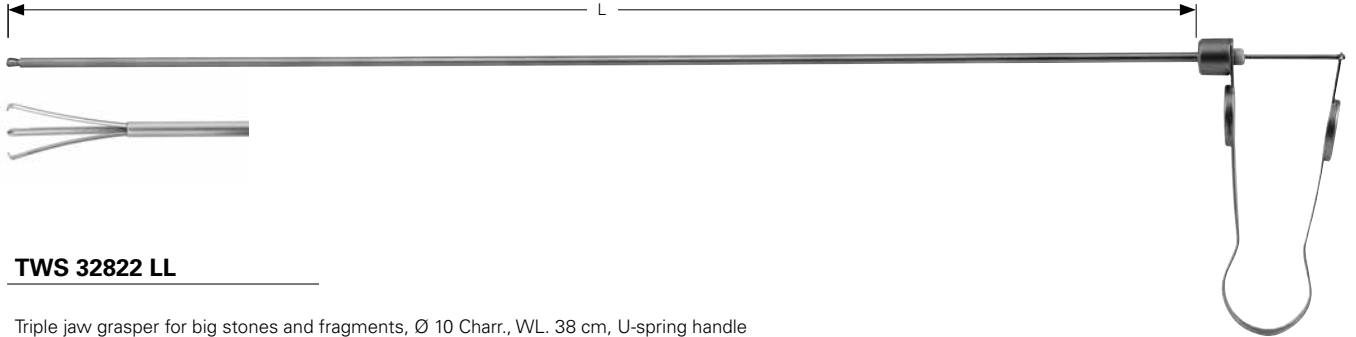

TWS 32822 LL

Triple jaw grasper for big stones and fragments, Ø 10 Charr., WL. 38 cm, U-spring handle

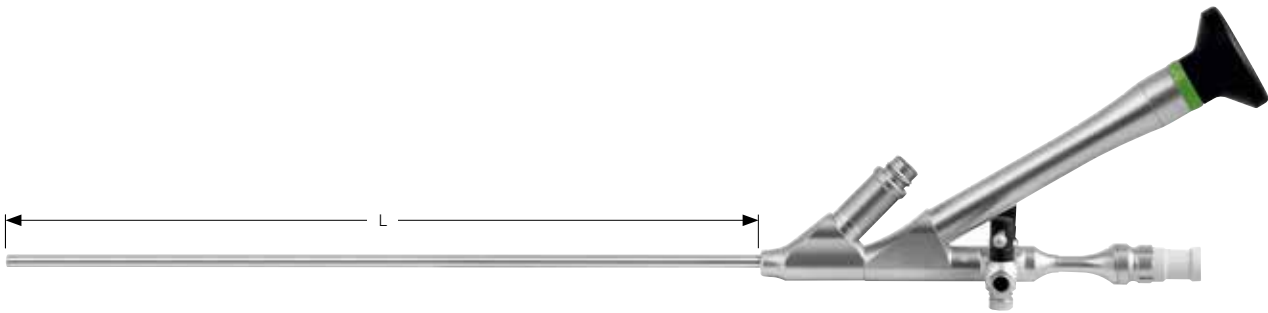

TWS 32823

HD Mini Compact Nephroscope, Ø 12 Charr., 0°, WL. 220 mm, round, working channel Ø 6.6 Charr.



TWS 32824

Adapter with silicone valve for Mini Compact Nephroscope



TWS 32825

Silicone valve for adapter 72-249-50



TWS 32826

Spare sealing cap

Sheaths for Mini Nephroscopy

Mini Nephroscopy sheath for continuous flow with 1 fixed stopcock



Size	Working length	Colour code	Sheath, only
15 / 18 Charr.	130,0 mm	■	TWS 32827
16,5 / 19,5 Charr.	130,0 mm	■	TWS 32828
21 / 24 Charr.	130,0 mm	■	TWS 32829

Dilator "One-Step" for Mini Nephroscopy sheaths with channel for guide wires



For sheaths	Channel	
15 / 18 Charr.	1 x 3 Charr.	TWS 32830
16,5 / 19,5 Charr.	2 x 3 Charr.	TWS 32831
21 / 24 Charr.	2 x 5 Charr.	TWS 32832



TWS 32833

Applicator for sealant, 2 parts incl. sheath and rod, for use with Mini Nephroscopy sheath

TWS 32834

Sheath for applicator

TWS 32835

Rod for applicator

Treasure Wright (U.K.) Ltd.

128-160 City Road, London, EC1V 2NX, United Kingdom
info@twrightmedical.com

Semi-rigid instruments for Mini Nephroscopy



TW Surgical

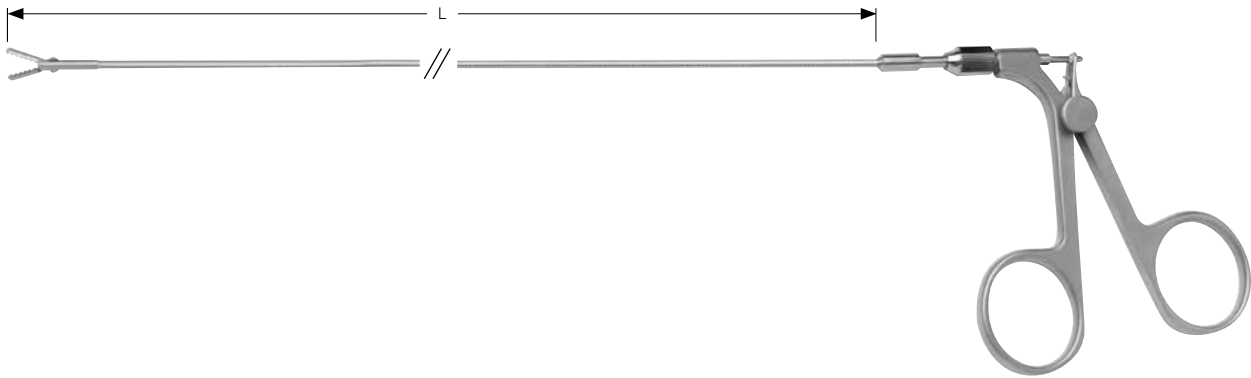

	Version	Ø	Length	Semi-rigid
	Stone grasping forceps, semi rigid, double action	5 Charr.	400 mm	TWS 32836
	Alligator grasping forceps, double action	5 Charr.	400 mm	TWS 32837
	Grasping forceps for larger stones, double action	5 Charr.	400 mm	TWS 32838
	Stone grasping forceps, long, fine serrated, double action	5 Charr.	400 mm	TWS 32839
	Biopsy forceps, spoon oval, double action	5 Charr.	400 mm	TWS 32840
	Scissors, blunt, single action	5 Charr.	400 mm	TWS 32841

Other lengths, diameters and jaw parts available on request.

Treasure Wright (U.K.) Ltd.

128-160 City Road, London, EC1V 2NX, United Kingdom
 info@twrightmedical.com

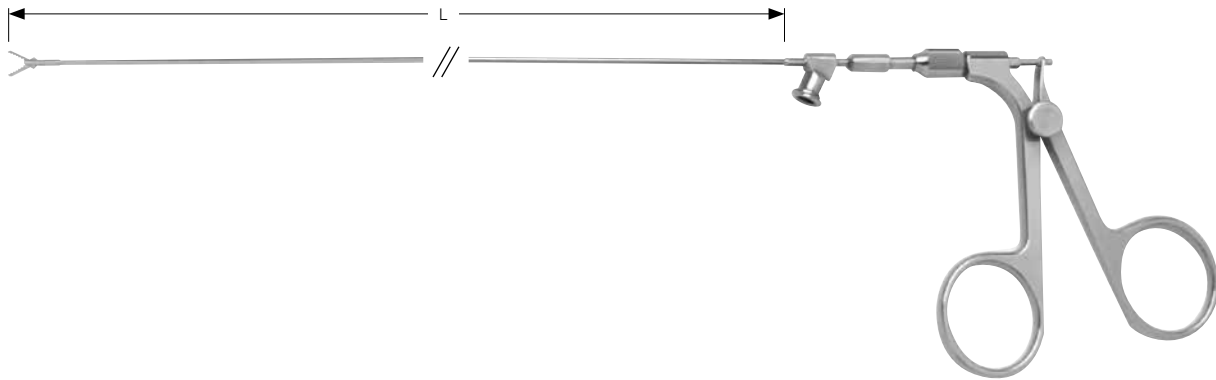

	Version	Ø	Length	Semi-rigid
	Stone grasping forceps, double action	5 Charr.	400 mm	TWS 32842 LL
	Alligator grasping forceps, double action	5 Charr.	400 mm	TWS 32843 LL
	Grasping forceps for larger stones, double action	5 Charr.	400 mm	TWS 32844 LL
	Stone grasping forceps, long, fine serrated, double action	5 Charr.	400 mm	TWS 32845 LL
	Biopsy forceps, spoon oval, double action	5 Charr.	400 mm	TWS 32846 LL
	Scissors, blunt, single action	5 Charr.	400 mm	TWS 32847 LL

Other lengths, diameters and jaw parts available on request.

HyONE Rotat- and detachable semi-rigid instruments

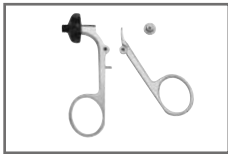
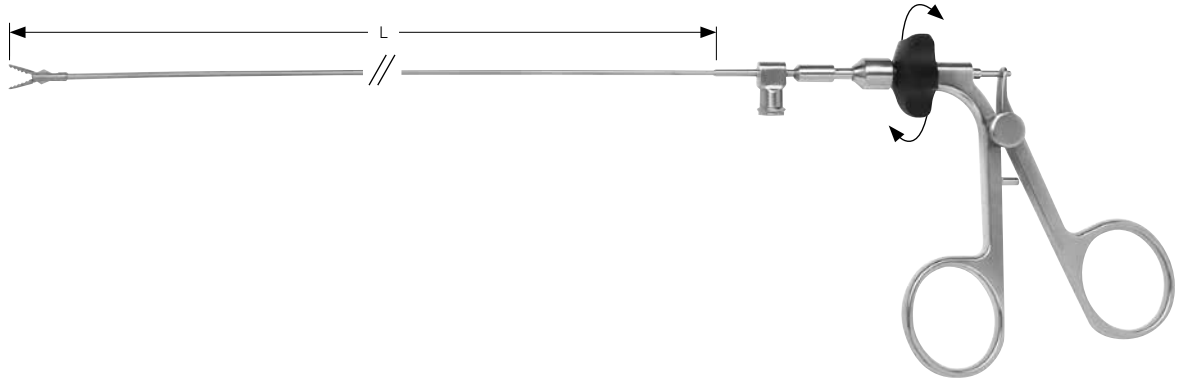

Stainless steel handle can be easily removed and detached for better cleaning.



360° rotatable shaft is smoothly to adjust and with a haptic feedback while rotating.



Integrated overload protection for a significantly longer service life.

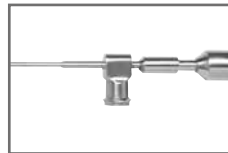

Luer-Lock cleaning port for an easier and faster cleaning without removing the handle.

	Version	Ø	Length	Insert, only	Complete with handle
	Stone grasping forceps, double action	5 Charr.	400 mm	TWS 32848 MI	TWS 32849 MC
	Alligator grasping forceps, double action	5 Charr.	400 mm	TWS 32850 MI	TWS 32851 MC
	Grasping forceps for larger stones, double action	5 Charr.	400 mm	TWS 32852 MI	TWS 32853 MC
	Stone grasping forceps, long, fine serrated, double action	5 Charr.	400 mm	TWS 32854 MI	TWS 32855 MC
	Biopsy forceps, spoon oval, double action	5 Charr.	400 mm	TWS 32856 MI	TWS 32857 MC
	Scissors, blunt, single action	5 Charr.	400 mm	TWS 32858 MI	TWS 32859 MC

Other lengths, diameters and jaw parts available on request.

TWS 32860 MH

HyONE Handle with rotating wheel and overload protection, stainless steel









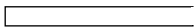

Treasure Wright (U.K.) Ltd.

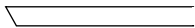
semi-flexible, 30.000 pixel







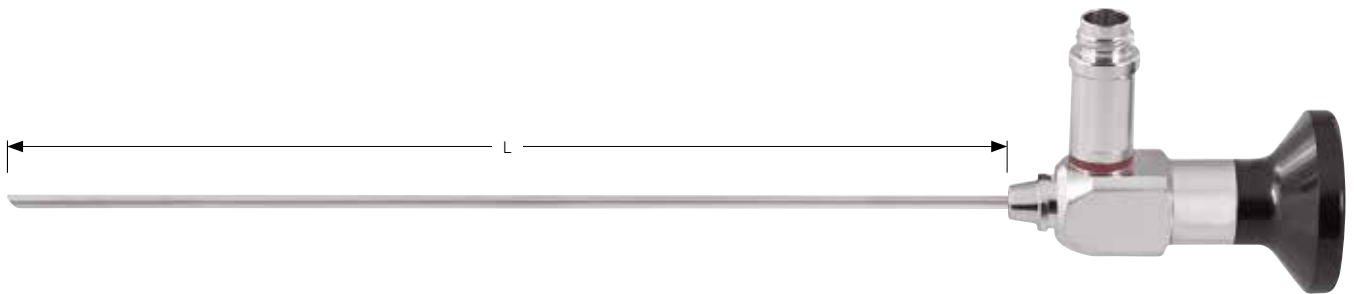

PAEDIATRIC-CYST

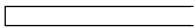
Length	Ø	0°		30°	
					
119,5 mm	1,9 mm	TWS 32861		TWS 32863	
187,5 mm	1,9 mm	TWS 32862		TWS 32864	

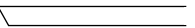

HD PAEDIATRIC-CYST

Length	Ø	0°		30°	
					
187,5 mm	2,7 mm	TWS 32865		TWS 32866	

Cysto-Urethroscope sheaths with 2 stopcocks



Size	For scopes	Colour code	Complete with obturator	Sheath, only	Obturator, only
7,5 Charr.	Ø 1,9 mm	■	TWS 32867	TWS 32873	TWS 32879
9,0 Charr.	Ø 1,9 mm	■	TWS 32868	TWS 32874	TWS 32880
9,5 Charr.	Ø 1,9 mm	■	TWS 32869	TWS 32875	TWS 32881
11 Charr.	Ø 1,9 / 2,7 mm	■	TWS 32870	TWS 32876	TWS 32882
13 Charr.	Ø 2,7 mm	■	TWS 32871	TWS 32877	TWS 32883
13 Charr.	Ø 2,7 mm	■	TWS 32872	TWS 32878	TWS 32884

Size	For scopes	Colour code	Sheath	Instrument channel
7,5 Charr.	Ø 1,9 mm 119,5 mm	■	TWS 32885	Diagnostik / Diagnostic Neonatal
9,0 Charr.	Ø 1,9 mm 119,5 mm	■	TWS 32886	1 x 3 Charr. Neonatal
9,5 Charr.	Ø 1,9 mm 187,5 mm	■	TWS 32887	1 x 3 Charr. Paediatric
11 Charr.	Ø 1,9 / 2,7 mm 187,5 mm	■	TWS 32888	Ø 1,9 mm = 1 x 5 Charr. Ø 2,7 mm = 1 x 3 Charr. Paediatric
13 Charr.	Ø 2,7 mm 187,5 mm	■	TWS 32889	1 x 3 Charr. Paediatric
13 Charr.	Ø 2,7 mm 187,5 mm	■	TWS 32890	1 x 5 Charr. 2 x 4 Charr. Paediatric



ALBARRAN

TWS 32891 13 Charr.

Working insert with deflecting mechanism for Cysto-Urethroscope sheath, with ratchet

TWS 32892 13 Charr.

Telescope bridge

Flexible instruments

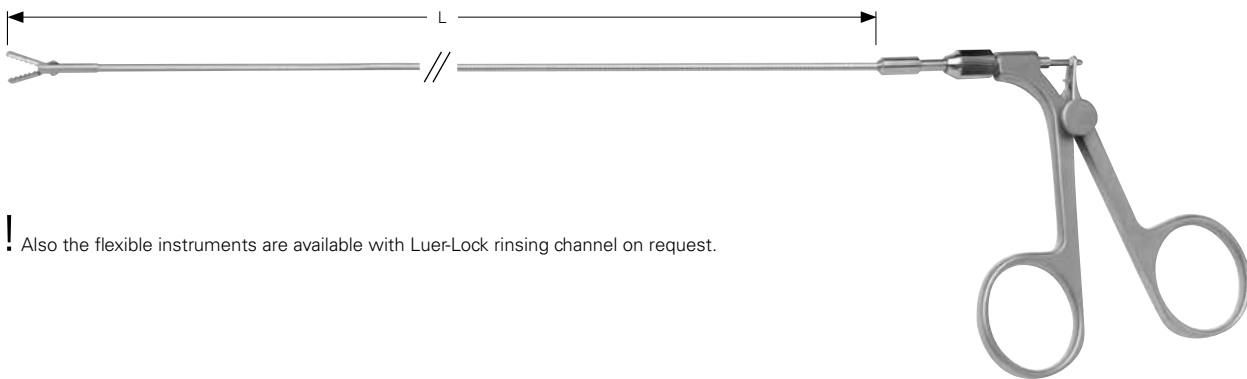

! Also the flexible instruments are available with Luer-Lock rinsing channel on request.



Version	Ø	Length	Flexible
Alligator Grasping forceps, double action	3 Charr.	280 mm	TWS 32893
Alligator Grasping forceps, double action	4 Charr.	280 mm	TWS 32894
Biopsy forceps, spoon oval, double action	3 Charr.	280 mm	TWS 32895
Biopsy forceps, spoon oval, double action	4 Charr.	280 mm	TWS 32896
Biopsy forceps, spoon oval, toothed, double action	4 Charr.	280 mm	TWS 32897
Scissors, blunt, single action	4 Charr.	280 mm	TWS 32898

Other lengths, diameters and jaw parts available on request.



TWS 32899 3 Charr.

TWS 32900 4 Charr.

TWS 32901 5 Charr.

Button tip electrode, WL. 450 mm



TWS 32902 3 Charr.

TWS 32903 5 Charr.

Needle electrode, WL. 450 mm

! Packing unit = 5 pieces

Treasure Wright (U.K.) Ltd.

128-160 City Road, London, EC1V 2NX, United Kingdom
info@twrightmedical.com



HD PAEDIATRIC-CYST

0°

Length	Ø	
187,5 mm	1,9 mm	TWS 32904 ■
187,5 mm	2,7 mm	TWS 32905 ■

Standard paediatric Resectoscopy sheath, 1 rotatable stopcock, with distal ceramic isolation



Size	For scopes	Colour code	Complete with obturator	Sheath, only	Obturator, only
11 Charr.	Ø 1,9 mm, 0°	■	TWS 32906	TWS 32907	TWS 32908



Size	For scopes	Colour code	Complete with obturator	Sheath, only	Obturator, only
13 Charr.	Ø 2,7 mm, 0°	■	TWS 32909	TWS 32910	TWS 32911

! Only for use with 0° Cystoscope

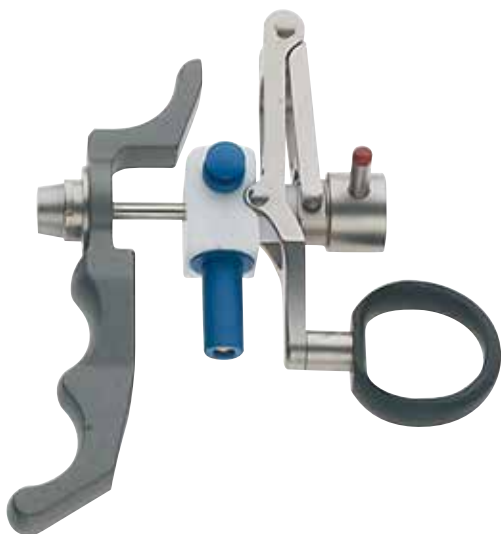

TWS 32912

Monopolar working element for paediatric Resectoscopy, passive cutting, single stem, open handle, for 11 and 13 Charr.

Monopolar electrodes

! Packing unit = 5 pieces



TWS 32913 11 Charr. ■
TWS 32914 13 Charr. ■

Loop electrode, small, 90°



TWS 32915 11 Charr. ■
TWS 32916 13 Charr. ■

Loop electrode, large, 90°



TWS 32917 11 Charr. ■
TWS 32918 13 Charr. ■

Knife electrode



TWS 32919 11 Charr. ■
TWS 32920 13 Charr. ■

Ball electrode



TWS 32921 11 Charr. ■
TWS 32922 13 Charr. ■

Hook electrode without ball





TWS 32923

Sterilisation tube for resectoscopy electrodes

Monopolar connecting cables with round plug



Plug instrument side

	Length	Item number
 Ø 4 mm	3,0 m	TWS 32924
	5,0 m	TWS 32925
 Ø 5 mm	3,0 m	TWS 32926
	5,0 m	TWS 32927
 Ø 8 mm	3,0 m	TWS 32928
	5,0 m	TWS 32929



HD PAEDIATRIC-CYST

0°

Length	Ø		
187,5 mm	2,0 mm	TWS 32930	■
187,5 mm	2,7 mm	TWS 32931	■

Paediatric Urethrotome sheath, 2 rotatable stopcocks

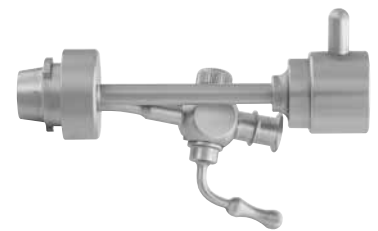
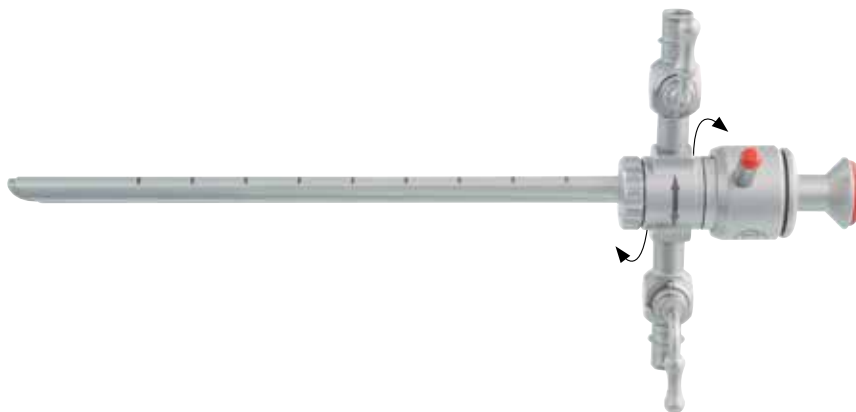

TWS 32932 11 Charr.
TWS 32933 13 Charr.

Telescope bridge for Urethrotome sheaths, 1 instrument channel 3 Charr.

Size	For scopes	Colour code	Complete with obturator	Sheath, only	Obturator, only
11 Charr.	Ø 2,0 mm, 0°	■	TWS 32934	TWS 32936	TWS 32938
13 Charr.	Ø 2,7 mm, 0°	■	TWS 32935	TWS 32937	TWS 32939

! Not to use with HF-Current

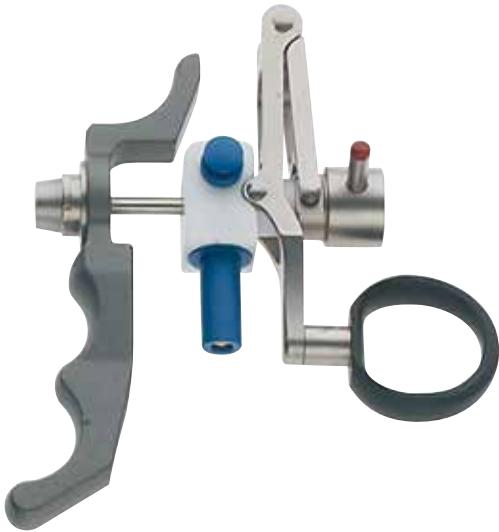

TWS 32940

Working element for paediatric Urethrotomy, passive cutting, single stem, open handle, for 11 and 13 Charr.

! Not to use with HF-Current



TWS 32941 11 Charr. ■
TWS 32942 13 Charr. ■

Knife, straight



TWS 32943 11 Charr. ■
TWS 32944 13 Charr. ■

Knife, round



TWS 32945 11 Charr. ■
TWS 32946 13 Charr. ■

Knife, hook shaped



TWS 32947 11 Charr. ■
TWS 32948 13 Charr. ■

Knife, sickle shaped



TWS 32949

Sterilisation tube for cold knives



ELLIK

TWS 32950 SET

Evacuator with standard connection, complete

ELLIK

TWS 32951

Tube with **Standard connection**

ELLIK

TWS 32952 SET

Glas bowl and rubber ball without tube and connection



ELLIK QUICK-LOCK

TWS 32954 SET

Evacuator with QUICK-LOCK connection, complete

ELLIK QUICK-LOCK

TWS 32953

Tube with **QUICK-LOCK connection**

For use with 18.5 Charr. Hybrid resectoscopy sheath



SUPRAPUBIC

TWS 32955 SET

Suprapubic aspiration set, complete



TWS 32956

Trocar with pyramidal tip



TWS 32957

Trocar with cannula tip



TWS 32958

Aspiration cannula



TWS 32959

Overflow cannula for pressure stabilisation



TWS 32960

Guide sleeve with lateral opening, for inserting a catheter



TWS 32961

Trocar sleeve 16 Charr., with pressure measuring channel



TWS 32962

Stabilisation disc, with lateral opening

Bladder syringes



TW Surgical



Bladder syringes with standard connection



Barrels

JANET-GS

TWS 32963	50,0 ml
TWS 32964	75,0 ml
TWS 32965	100,0 ml
TWS 32966	150,0 ml
TWS 32967	200,0 ml

JANET-GS

TWS 32968	50,0 ml
TWS 32969	75,0 ml
TWS 32970	100,0 ml
TWS 32971	150,0 ml
TWS 32972	200,0 ml



Bladder syringes with QUICK-LOCK connection

JANET-GS QUICK-LOCK

TWS 32973	150,0 ml
------------------	----------

Treasure Wright (U.K.) Ltd.

128-160 City Road, London, EC1V 2NX, United Kingdom
info@twrightmedical.com



GUYON

TWS 32974 39,0 cm, 15 1/2"



GUYON

TWS 32975 35,0 cm, 13 3/4"

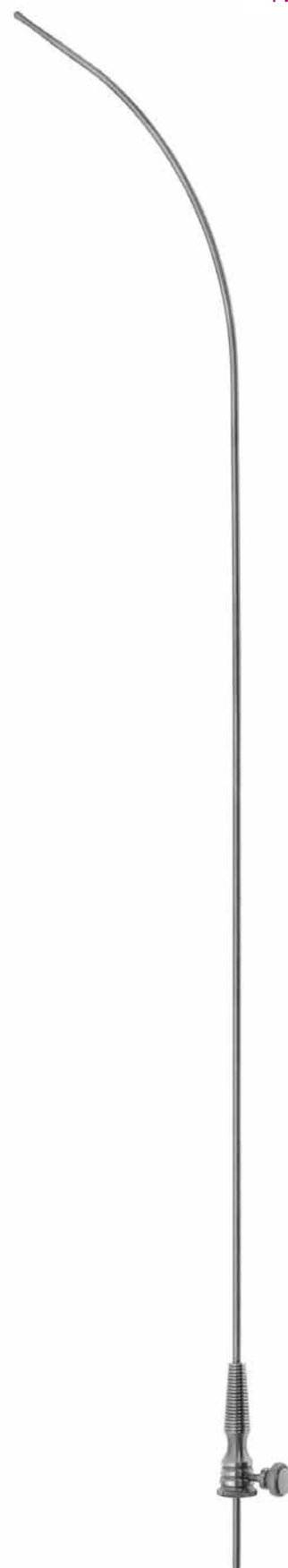

DITTEL

TWS 32976 46,0 cm, 18"



GUYON

TWS 32977 SET

Set with 21 bougies, Charr. 10 to 30, with 4 filiform bougies, in metal case 42.0 x 17.5 x 4.0 cm

VAN BUREN

TWS 32978 SET

Set with 26 bougies, Charr. 8 to 36

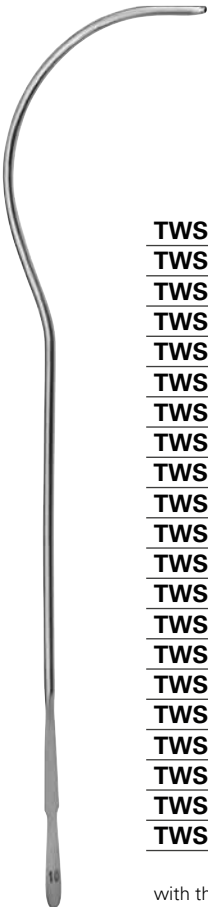

- TWS 32979** 10 Charr.
- TWS 32980** 11 Charr.
- TWS 32981** 12 Charr.
- TWS 32982** 13 Charr.
- TWS 32983** 14 Charr.
- TWS 32984** 15 Charr.
- TWS 32985** 16 Charr.
- TWS 32986** 17 Charr.
- TWS 32987** 18 Charr.
- TWS 32988** 19 Charr.
- TWS 32989** 20 Charr.
- TWS 32991** 21 Charr.
- TWS 32992** 22 Charr.
- TWS 32993** 23 Charr.
- TWS 32994** 24 Charr.
- TWS 32995** 25 Charr.
- TWS 32996** 26 Charr.
- TWS 32997** 27 Charr.
- TWS 32998** 28 Charr.
- TWS 32999** 29 Charr.
- TWS 32990** 30 Charr.

with thread

GUYON

TWS 33026 - TWS 33027 26,0 cm, 10 1/4"



- TWS 33000** 8 Charr.
- TWS 33020** 9 Charr.
- TWS 33010** 10 Charr.
- TWS 33001** 11 Charr.
- TWS 33002** 12 Charr.
- TWS 33003** 13 Charr.
- TWS 33004** 14 Charr.
- TWS 33005** 15 Charr.
- TWS 33006** 16 Charr.
- TWS 33007** 17 Charr.
- TWS 33008** 18 Charr.
- TWS 33009** 19 Charr.
- TWS 33021** 20 Charr.
- TWS 33011** 21 Charr.
- TWS 33012** 22 Charr.
- TWS 33013** 23 Charr.
- TWS 33014** 24 Charr.
- TWS 33015** 25 Charr.
- TWS 33016** 26 Charr.
- TWS 33017** 27 Charr.
- TWS 33018** 28 Charr.
- TWS 33019** 29 Charr.
- TWS 33023** 30 Charr.
- TWS 33022** 32 Charr.
- TWS 33024** 34 Charr.
- TWS 33025** 36 Charr.

VAN BUREN

TWS 33028 - TWS 33029 27,5 cm, 10 3/4"

Dilating bougies



TWS 33030	8 Charr.
TWS 33040	9 Charr.
TWS 33060	10 Charr.
TWS 33031	11 Charr.
TWS 33032	12 Charr.
TWS 33033	13 Charr.
TWS 33034	14 Charr.
TWS 33035	15 Charr.
TWS 33036	16 Charr.
TWS 33037	17 Charr.
TWS 33038	18 Charr.
TWS 33039	19 Charr.
TWS 33050	20 Charr.
TWS 33041	21 Charr.
TWS 33042	22 Charr.
TWS 33043	23 Charr.
TWS 33044	24 Charr.
TWS 33045	25 Charr.
TWS 33046	26 Charr.
TWS 33047	27 Charr.
TWS 33048	28 Charr.
TWS 33049	29 Charr.
TWS 33051	30 Charr.

DITTEL

TWS 33068 - TWS 33069 27 cm, 10 ½"



36-104-00	0 2 E.G.
36-104-01	1 E.G.
TWS 33052	½ 3 E.G.
TWS 33053	1 4 E.G.
TWS 33054	2 5 E.G.
TWS 33055	3 6 E.G.
TWS 33056	4 7 E.G.
TWS 33057	5 8 E.G.
TWS 33058	6 9 E.G.
TWS 33059	7 10 E.G.
36-104-10	8 11 E.G.
TWS 33061	9 12 E.G.
TWS 33062	10 13 E.G.
TWS 33063	11 14 E.G.
TWS 33064	12 15 E.G.
TWS 33065	13 16 E.G.
TWS 33066	14 17 E.G.
TWS 33067	15 18 E.G.

LISTER

TWS 33070 - TWS 33071 28,0 cm, 10 ¾"



TWS 33072	8 Charr.
TWS 33073	9 Charr.
TWS 33080	10 Charr.
TWS 33081	11 Charr.
TWS 33082	12 Charr.
TWS 33083	13 Charr.
TWS 33074	14 Charr.
TWS 33075	15 Charr.
TWS 33076	16 Charr.
TWS 33077	17 Charr.
TWS 33078	18 Charr.
TWS 33079	19 Charr.
TWS 33090	20 Charr.
TWS 33091	21 Charr.
TWS 33092	22 Charr.
36-105-23	23 Charr.
TWS 33084	24 Charr.
TWS 33085	25 Charr.
TWS 33086	26 Charr.
TWS 33087	27 Charr.
TWS 33088	28 Charr.
TWS 33089	29 Charr.
TWS 33093	30 Charr.

DITTEL

TWS 33095 - TWS 33096 22,5 cm, 9"

DITTEL

TWS 33094 SET

Set with 23 bougies, Charr. 8 to 30



- TWS 33097** 6 Charr.

- TWS 33105** 7 Charr.

- TWS 33098** 8 Charr.

- TWS 33099** 9 Charr.

- TWS 33100** 10 Charr.

- TWS 33101** 11 Charr.

- TWS 33102** 12 Charr.

- TWS 33103** 13 Charr.

- TWS 33104** 14 Charr.

- TWS 33106** 16 Charr.

- TWS 33108** 18 Charr.

- TWS 33107** 20 Charr.

- TWS 33109** 22 Charr.

- TWS 33110** 24 Charr.

for women



- TWS 33113** 8 Charr.

- TWS 33115** 10 Charr.

- TWS 33112** 12 Charr.

- TWS 33114** 14 Charr.

- TWS 33116** 16 Charr.

- TWS 33117** 18 Charr.

- TWS 33118** 20 Charr.

for men

TWS 33119 - TWS 33120 15,0 cm, 6 "

TWS 33121 - TWS 33122 25,0 cm, 10 "

! SUITABLE FOR DI-WATER! REPROCESSABLE!



TWS 33123 SET

complete, with 4 tips, 1.5 m pressure tube

TWS 33124

Water jet pistol, only

Tips, SUITABLE FOR DI-WATER! REPROCESSABLE!



TWS 33125

Spray nozzle, stainless steel



TWS 33126

Luer-Lock connector



TWS 33127

Shower nozzle, stainless steel



TWS 33128

Luer-Lock connector, stainless steel



TWS 33129

Tube nozzle, size 6 (4 mm)



TWS 33130

Pressure tube for DI-Water, 1.5 m

Endoscopy Baskets

Endoscopy baskets with silicone holders for endoscopes



Dimensions	1 Endoscope	2 Endoscopes
290 x 80 x 55 mm	TWS 33131	TWS 33134
460 x 80 x 55 mm	TWS 33132	TWS 33135
670 x 80 x 55 mm	TWS 33133	

Endoscopy baskets with silicone holders for a variable numbers of endoscopes



Dimensions	
290 x 160 x 52 mm	TWS 33136
310 x 150 x 77 mm	TWS 33137
460 x 160 x 52 mm	TWS 33138
460 x 225 x 52 mm	TWS 33139

Sterilization baskets for a variable numbers of endoscopes / URS with adjustable holding device

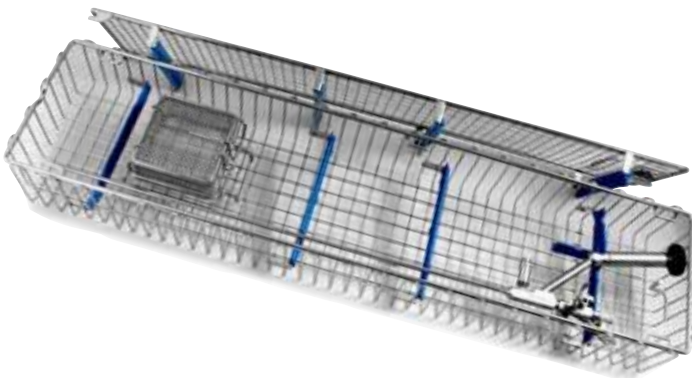

TWS 33140 580 x 160 x 52 mm

Suitable for URS with working length **315 mm**

TWS 33141 640 x 150 x 77 mm

Suitable for URS with working length **430 mm**

! Delivery without endoscope

Treasure Wright (U.K.) Ltd.

128-160 City Road, London, EC1V 2NX, United Kingdom
info@twrightmedical.com

Endoscopy Baskets, Scope Containers

VEQTRON ICG/NIR basket for laparoscope and light cable, complete with racks and lid

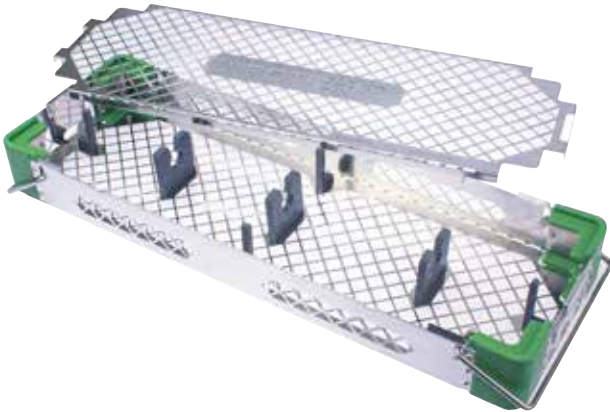

Dimensions

506 x 172 x 56 mm

TWS 33142 NIR

Basket for Cystoscope/Hysteroscope and light cable, complete with racks and lid



Dimensions

406 x 172 x 56 mm

TWS 33143

Alu scope container, without filters, only for transport and storage, with endoscope holding devices



Dimensions

275 x 70 x 65 mm

TWS 33144

470 x 82 x 74 mm

TWS 33145

Treasure Wright (U.K.) Ltd.

128-160 City Road, London, EC1V 2NX, United Kingdom
info@twrightmedical.com

Sterilization basket for 2 endoscopes and light cable

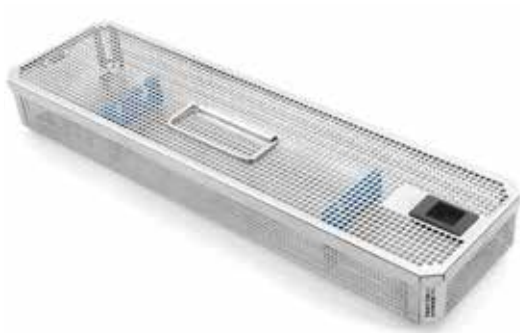

Dimensions

492 x 134 x 65 mm

TWS 33146

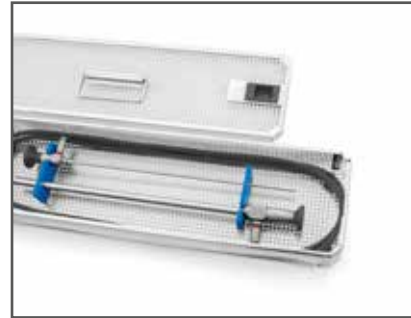

! Delivery without endoscope and light cable

Sterilizing container Endo, complete



Bottom non perforated



Bottom perforated



Dimensions

532 x 160 x 100 mm

TWS 33147

Dimensions

532 x 160 x 100 mm

TWS 33148

Container bottom



Dimensions

528 x 145 x 88 mm

TWS 33149

Dimensions

528 x 145 x 88 mm

TWS 33150

Container lid with filter holding device



Dimensions

532 x 160 mm

TWS 33151

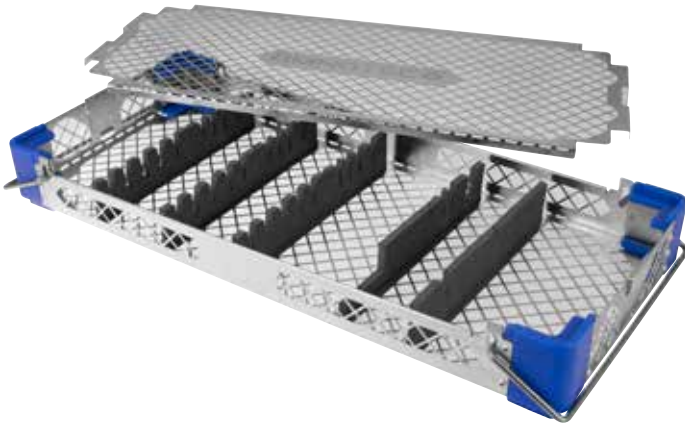

TWS 33152 540 x 243 x 66 mm

Basket for Resectoscopy / Cystoscopy Set, complete with racks and lid

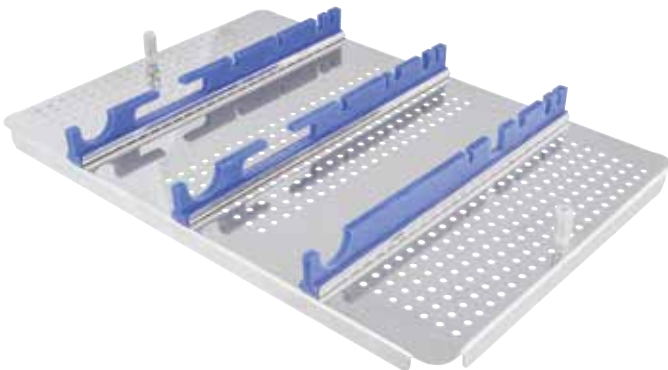

TWS 33153

Insert for Resectoscopy Set, for standard wire baskets



TW
Surgical

Treasure Wright (U.K.) Ltd.

**Address: 128-160 , City Road,
London EC1V 2NX. United Kingdom**

www.twrightmedical.com

info@twrightmedical.com



TW Surgical



**UK
CA CE**