



TW
Surgical

MICRO SCISSORS



**UK
CA** **CE**



TW Surgical

Treasure Wright (U.K.) Ltd.











www.twrightmedical.com

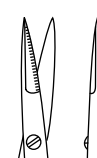
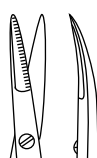

info@twrightmedical.com

Micro Scissors with round handle



				
			 	 
	9 mm	9 mm	9 mm	9 mm
15,0 cm; 5 7/8"	TWS 84-2519/97	TWS 84-2519/98	TWS 84-2519/99	TWS 84-2520/00
	14 mm	14 mm	14 mm	14 mm
15,0 cm; 5 7/8"	TWS 84-2520/01	TWS 84-2520/02	TWS 84-2520/03	TWS 84-2520/04



Adventitia









Dissection

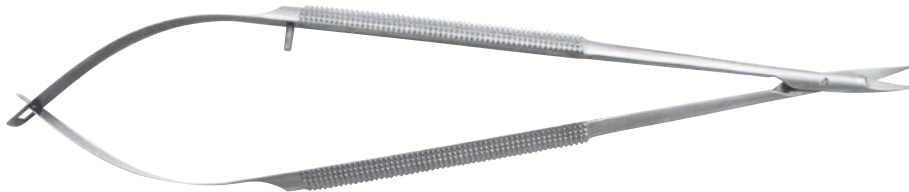

Toothed

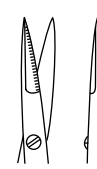
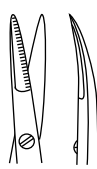
Micro Scissors with round handle



					
	A	A	A 	D 	D
	10 mm	10 mm	10 mm	10 mm	10 mm
15,0 cm; 5 7/8"	TWS 84-2520/05	TWS 84-2520/06			
18,0 cm; 7 1/8"	TWS 84-2520/07	TWS 84-2520/08	TWS 84-2520/09	TWS 84-2520/10	TWS 84-2520/11
21,0 cm; 8 2/8"	TWS 84-2520/12	TWS 84-2520/13			
23,0 cm; 9"	TWS 84-2520/14	TWS 84-2520/15			



Adventitia





Dissection



Toothed

Micro Scissors with flat handle



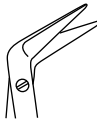
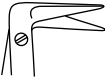





					
	125°	25°	45°	60°	90°
	10 mm	10 mm	10 mm	10 mm	10 mm
18,0 cm; 7 1/8"	TWS 84-2520/16	TWS 84-2520/17	TWS 84-2520/18	TWS 84-2520/19	TWS 84-2520/20

	125°	25°	45°	60°	90°
	7 mm	7 mm	7 mm	7 mm	7 mm
18,0 cm; 7 1/8"	TWS 84-2520/21	TWS 84-2520/22	TWS 84-2520/23	TWS 84-2520/24	TWS 84-2520/25

Micro Scissors with flat handle



				
	A	D	A 	D 
	9 mm	9 mm	9 mm	9 mm
15,0 cm; 5 7/8"	TWS 84-2520/26	TWS 84-2520/27	TWS 84-2520/28	TWS 84-2520/29
	14 mm	14 mm	14 mm	14 mm
15,0 cm; 5 7/8"	TWS 84-2520/30	TWS 84-2520/31	TWS 84-2520/32	TWS 84-2520/33



Adventitia









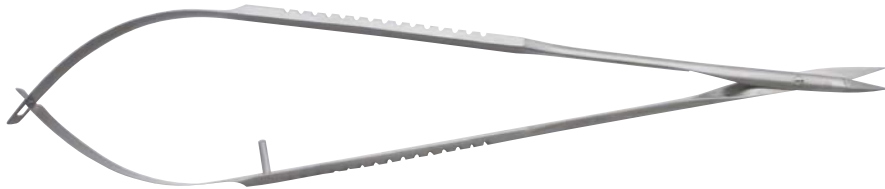

Dissection



Toothed

Micro Scissors with flat handle



					
	A	A	A 	D 	D
	10 mm	10 mm	10 mm	10 mm	10 mm
15,0 cm; 5 7/8"	TWS 84-2520/34	TWS 84-2520/35			
18,0 cm; 7 1/8"	TWS 84-2520/40	TWS 84-2520/41	TWS 84-2520/42	TWS 84-2520/43	TWS 84-2520/44
21,0 cm; 8 2/8"	TWS 84-2520/36	TWS 84-2520/37			
23,0 cm; 9	TWS 84-2520/38	TWS 84-2520/39			



Adventitia





Dissection





Toothed

JACOBSON

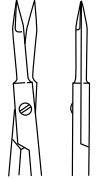
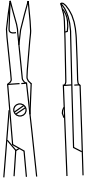

				
	15 mm	15 mm	12 mm	12 mm
20,5 cm; 8 1/8"	TWS 84-2520/45	TWS 84-2520/46	TWS 84-2520/47	TWS 84-2520/48

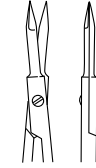
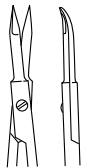

				
15,5 cm; 6 1/8"	TWS 84-2520/49	TWS 84-2520/50	TWS 84-2520/51	TWS 84-2520/52
18,5 cm; 7 2/8"	TWS 84-2520/53	TWS 84-2520/54	TWS 84-2520/55	TWS 84-2520/56

NOYES

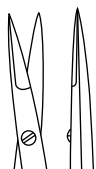

15 mm

TWS 84-2520/57



15 mm

TWS 84-2520/58

12,0 cm; 4 6/8"



15 mm

TWS 84-2520/59

10,0 cm; 3 7/8"

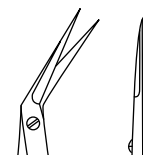

45°

15 mm









9,5 cm; 3 6/8"

TWS 84-2520/60



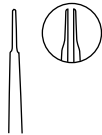
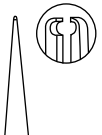



Micro Forceps with round handle

with counter balance



						
						
					Dilatation	Pierce
	0,3 mm	0,3 mm	0,3 mm, 45°	1,0 x 0,5 mm	0,3 mm	0,3 mm
15,0 cm; 5 7/8"	TWS 84-2520/61	TWS 84-2520/62	TWS 84-2520/63	TWS 84-2520/64	TWS 84-2520/65	TWS 84-2520/66
18,0 cm; 7 1/8"	TWS 84-2520/67	TWS 84-2520/68	TWS 84-2520/69	TWS 84-2520/70	TWS 84-2520/71	TWS 84-2520/72



						
	0,4 mm	0,4 mm	0,7 mm	0,7 mm	1,0 x 0,5 mm	2,0 x 1,0 mm
15,0 cm; 5 7/8"	TWS 84-2520/73	TWS 84-2520/74	TWS 84-2520/75	TWS 84-2520/76	TWS 84-2520/77	TWS 84-2520/78
18,0 cm; 7 1/8"	TWS 84-2520/79	TWS 84-2520/80	TWS 84-2520/81	TWS 84-2520/82	TWS 84-2520/83	TWS 84-2520/84
21,0 cm; 8 2/8"			TWS 84-2520/85	TWS 84-2520/86	TWS 84-2520/87	TWS 84-2520/88
23,0 cm; 9"			TWS 84-2520/89	TWS 84-2520/90	TWS 84-2520/91	TWS 84-2520/92



Diamond coated

Micro Forceps with round handle

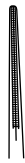

Atrauma

1,2 mm

15,0 cm; 5 7/8"	TWS 84-2520/93
18,0 cm; 7 1/8"	TWS 84-2520/94
23,0 cm; 9"	TWS 84-2520/95



1x2



0,3 mm



1x2



0,3 mm



1x2



0,7 mm



1x2





0,7 mm



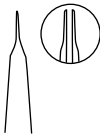
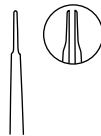
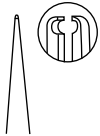
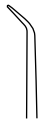

15,0 cm; 5 7/8"	TWS 84-2520/95	TWS 84-2520/97	TWS 84-2520/99	TWS 84-2521/03
18,0 cm; 7 1/8"	TWS 84-2520/96	TWS 84-2520/98	TWS 84-2521/00	TWS 84-2521/04
21,0 cm; 8 2/8"			TWS 84-2521/01	TWS 84-2521/05
23,0 cm; 9"			TWS 84-2521/02	TWS 84-2521/06

JUWELIER



						
		Dilatation	Dilatation	Pierse	45°	90°
	0,3 mm	0,2 mm	0,3 mm	0,3 mm	0,3 mm	0,3 mm
11,0 cm; 4 3/8"	TWS 84-2521/07	TWS 84-2521/09	TWS 84-2521/10	TWS 84-2521/11	TWS 84-2521/12	TWS 84-2521/13
13,0 cm; 5 1/8"	TWS 84-2521/08	TWS 84-2521/14	TWS 84-2521/15	TWS 84-2521/16	TWS 84-2521/17	TWS 84-2521/18

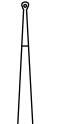
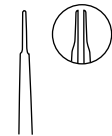
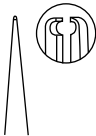





						
					Dilatation	Pierse
	0,4 mm	0,4 mm	0,4 mm, 45°	1,0 x 0,5 mm	0,3 mm	0,4 mm
15,0 cm; 5 7/8"	TWS 84-2521/19	TWS 84-2521/21	TWS 84-2521/23	TWS 84-2521/25	TWS 84-2521/27	TWS 84-2521/29
18,0 cm; 7 1/8"	TWS 84-2521/20	TWS 84-2521/22	TWS 84-2521/24	TWS 84-2521/26	TWS 84-2521/28	TWS 84-2521/30



Diamond coated





Micro Needle Holders with round handle







				
	0,3 mm	0,3 mm	0,3 mm	0,3 mm
15,0 cm; 5 7/8"	TWS 84-2521/31	TWS 84-2521/32	TWS 84-2521/33	TWS 84-2521/34
	w/o catch		with catch	

Micro Needle Holders with round handle







				
	0,4 mm	0,4 mm	0,4 mm	0,4 mm
15,0 cm; 5 7/8"	TWS 84-2521/35	TWS 84-2521/37	TWS 84-2521/39	TWS 84-2521/41
18,0 cm; 7 1/8"	TWS 84-2521/36	TWS 84-2521/38	TWS 84-2521/40	TWS 84-2521/42
	w/o catch		with catch	

				
	0,8 mm	0,8 mm	0,8 mm	0,8 mm
15,0 cm; 6"	TWS 84-2521/43	TWS 84-2521/47	TWS 84-2521/51	TWS 84-2521/55
18,0 cm; 7 1/8"	TWS 84-2521/44	TWS 84-2521/48	TWS 84-2521/52	TWS 84-2521/56
21,0 cm; 8 2/8"	TWS 84-2521/45	TWS 84-2521/49	TWS 84-2521/53	TWS 84-2521/57
23,0 cm; 9"	TWS 84-2521/46	TWS 84-2521/50	TWS 84-2521/54	TWS 84-2521/58
	w/o catch		with catch	

BARRAQUER-TROUTMAN







		
10,5 cm; 4 1/8"	TWS 84-2521/59	TWS 84-2521/60
ohne Sperre w/o catch		

		
10,5 cm; 4 1/8"	TWS 84-2521/61	TWS 84-2521/62
11,5 cm; 4 4/8"	TWS 84-2521/63	TWS 84-2521/64
with catch		



BARRAQUER





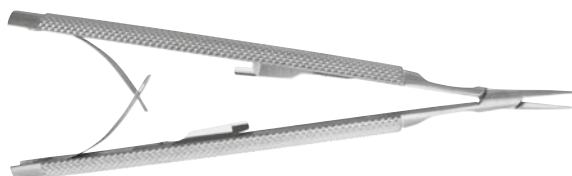

				
13,5 cm; 5 3/8"	TWS 84-2521/65	TWS 84-2521/66	TWS 84-2521/67	TWS 84-2521/68
w/o catch			with catch	

CASTROVIEJO







		
12,0 cm; 4 6/8"	TWS 84-2521/69	TWS 84-2521/70
with catch		



				
	2,0 mm	2,0 mm	2,0 mm	2,0 mm
14,0 cm; 5 4/8"	TWS 84-2521/71	TWS 84-2521/72	TWS 84-2521/73	TWS 84-2521/74
18,0 cm; 7 1/8"	TWS 84-2521/75	TWS 84-2521/76	TWS 84-2521/77	TWS 84-2521/78
21,0 cm; 8 2/8"	TWS 84-2521/79	TWS 84-2521/80	TWS 84-2521/81	TWS 84-2521/82
23,0 cm; 9"	TWS 84-2521/83	TWS 84-2521/84	TWS 84-2521/85	TWS 84-2521/86
w/o catch		with catch		





CASTROVIEJ



				
	0,3 mm	0,3 mm	0,3 mm	0,3 mm
15,0 cm; 5 7/8"	TWS 84-2521/87	TWS 84-2521/88	TWS 84-2521/89	TWS 84-2521/90
	w/o catch		with catch	

CASTROVIEJO







				
	0,4 mm	0,4 mm	0,4 mm	0,4 mm
18,0 cm; 7 1/8"	TWS 84-2521/91	TWS 84-2521/92	TWS 84-2521/93	TWS 84-2521/94
	w/o catch		with catch	



Diamond coated

CASTROVIEJO



				
14,5 cm; 5 6/8"	TWS 84-2521/95	TWS 84-2521/96	TWS 84-2521/97	TWS 84-2521/98
	w/o catch		with catch	

CASTROVIEJO



	
14,5 cm; 5,8"	TWS 84-2521/99
	w/o catch

KALT

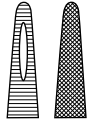

13,5 cm; 5 1/8"

TWS 84-2522/00

ARRUGA







13,5 cm; 5 3/8"

TWS 84-2522/03

TWS 84-2522/04





CASTROVIEJO



				
14,5 cm; 5 3/4"	TWS 84-2522/05	TWS 84-2522/06	TWS 84-2522/07	TWS 84-2522/08
18,0 cm; 7"	TWS 84-2522/09	TWS 84-2522/10	TWS 84-2522/11	TWS 84-2522/12
with catch				

BARRAQUER



				
14,5 cm; 5 3/4"	TWS 84-2522/13	TWS 84-2522/15	TWS 84-2522/17	TWS 84-2522/19
18,0 cm; 7"	TWS 84-2522/14	TWS 84-2522/16	TWS 84-2522/18	TWS 84-2522/20
with catch				



TW
Surgical

Treasure Wright (U.K.) Ltd.

**Address: 128-160 , City Road,
London EC1V 2NX. United Kingdom**

www.twrightmedical.com

info@twrightmedical.com



TW Surgical



**UK
CA CE**